

Digital Video Recorder

SHADOW SERIES / PRO SERIES / HD SERIES

Manual

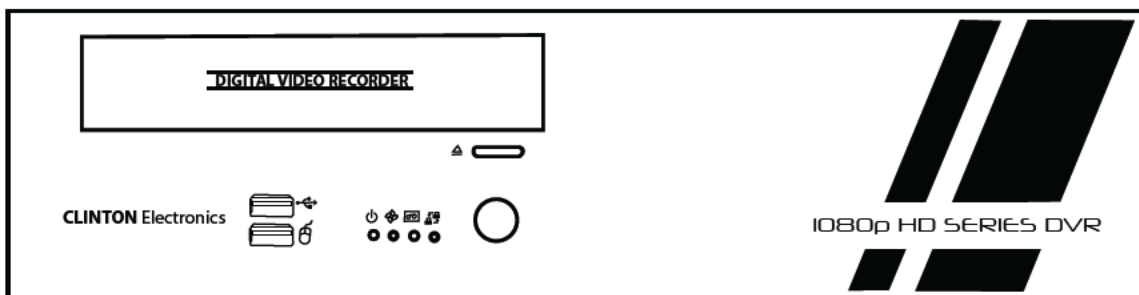
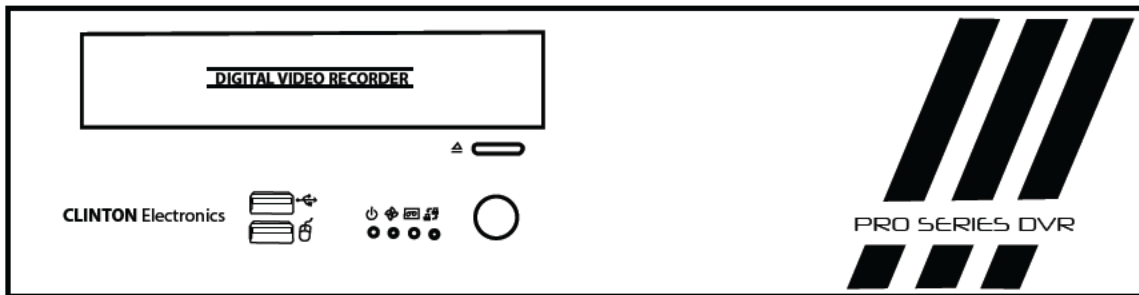
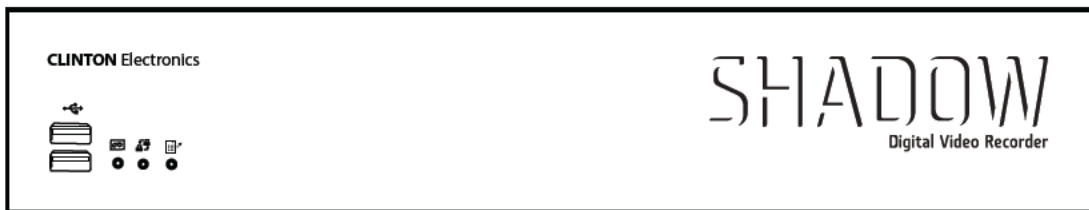
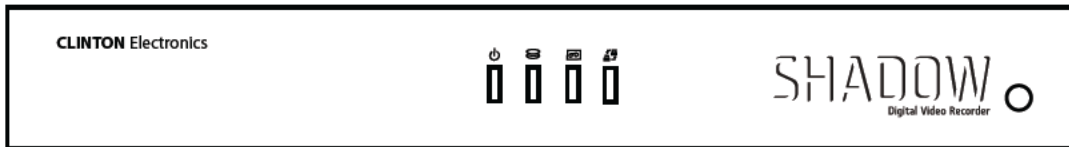

Warning & Compliance



The lightning flash with an arrowhead symbol, within an equilateral triangle is intended to alert the user to the presence of uninsulated dangerous voltage within the product's enclosure that may be of sufficient magnitude to constitute a risk of electric shock to persons.



The exclamation point within an equilateral triangle is intended to alert the user to the presence of important operating and maintenance (servicing) instructions in the literature accompanying the appliance.

INFORMATION - This equipment has been tested and found to comply with limits for a Class A digital device, pursuant to part 15 of the FCC Rules. These limits are designed to provide reasonable protection against harmful interference when the equipment is operated in a commercial environment. This equipment generates, uses, and can radiate radio frequency energy and, if not installed and used in accordance with the instruction manual, may cause harmful interference to radio communications. Operation of this equipment in a residential area is likely to cause harmful interference in which case the user will be required to correct the interference at his own expense.

WARNING - Changes or modifications not expressly approved by the manufacturer could void the user's authority to operate the equipment.

CAUTION : To prevent electric shock and risk of fire hazards:

- ◆ Do NOT use power sources other than that specified.
- ◆ Do NOT expose this appliance to rain or moisture.

This installation should be made by a qualified service person and should conform to all local codes.



RoHS

This directive restricts the use of six hazardous materials in the manufacture of various type of electronic and electrical equipment.



USA (FCC)

This device has been tested and found to comply with the limits of Class A computing device pursuant to part 15 of the FCC rules.



Europe (CE)

By affixing the CE marking, the manufacturer assures that the item meets all the essential requirements of all applicable EU directives.



Japan (PSE)

The purpose of the Electrical Appliance and Material Safety Law is to prevent hazards and disturbances resulting from electrical appliances.

Table Of Contents

Important Safeguards	5-6
Hardware	7
Shadow Series	7-8
Pro Series	9
HD Series	10
Remote Control Overview	11
Live View Screen Layout	12
Menus & Login	13
Top & Bottom Menus	13
Camera Menu	14-16
Top Menu- Setup & User Login	17
Setup Menu	18
General Setup	18
Date & Time	19
Alarm Out	20
Disk Setup	21
RAID	22-23
Monitor	24
Account	25
Configuration	26
Shutdown	27
Camera Setup	28
Camera	28
PTZ	29
Spot	30
Sequence	31
Private Zone	32
Event Setup	33
Motion	34
Alarm In	35
Video Loss	36
System	37
Email	38
Display	38
Record Setup	39
Resolution	39
Schedule	40
Record	41
Event	42
Audio	42
Manual	43

Table Of Contents

Setup Menu- continued	44
Network Setup	44
Ethernet	44
Client	45
RS-232 & RS-485 Serial	46
DDNS	47
E-Mail	48
Net Frame	49
System Menu	50
System Log	50
Status	51-52
Search Menu	53
Search Screen Layout	53
Popup Menu & Controls	54
Calendar Search	55
Event Search	56
Overlapped List	57
Panorama & Smart Search	58
Backup Menu	59
Backup	59
SMS	60
Upgrade	61
Web Viewer	62
Connect	62
Functions	63
Mobile App	64
Setup	64
Operation	65
Specifications	66
Shadow Series	66
Pro Series	67
HD Series	68

Important Safeguards

1. Read Instructions

All the safety and operating instructions should be read before the appliance is operated.

2. Retain Instructions

The safety and operating instructions should be retained for future reference.

3. Cleaning

Unplug this equipment from the wall outlet before cleaning it. Do not use liquid aerosol cleaners. Use a damp soft cloth for cleaning.

4. Attachments

Never add any attachments and/or equipment without the approval of the manufacturer as such additions may result in the risk of fire, electric shock or other personal injury.

5. Water and/or Moisture

Do not use this equipment near water or in contact with water.

6. Accessories

Do not place this equipment on an unstable cart, stand or table. The equipment may fall, causing serious injury to a child or adult, and serious damage to the equipment. Wall or shelf mounting should follow the manufacturer's instructions, and should use a mounting kit approved by the manufacturer.

7. Power Sources

This equipment should be operated only from the type of power source indicated on the marking label. If you are not sure of the type of power, please consult your equipment dealer or local power company.

8. Power Cords

Operator or installer must remove power and communications connections before handling the equipment.

9. Lightning

For added protection for this equipment during a lightning storm, or when it is left unattended and unused for long periods of time, unplug it from the wall outlet and disconnect the cable system. This will prevent damage to the equipment due to lightning and power-line surges.

10. Overloading

Do not overload wall outlets and extension cords as this can result in the risk of fire or electric shock.

11. Objects and Liquids

Never push objects of any kind through openings of this equipment as they may touch dangerous voltage points or short out parts that could result in a fire or electric shock. Never spill liquid of any kind on the equipment.

12. Servicing

Do not attempt to service this equipment yourself. Refer all servicing to qualified service personnel.

Important Safeguards

13. Damage Requiring Service

Unplug this equipment from the wall outlet and refer servicing to qualified service personnel under the following conditions:

- A. When the power-supply cord or the plug has been damaged.
- B. If liquid is spilled, or objects have fallen into the equipment.
- C. If the equipment has been exposed to rain or water.
- D. If the equipment does not operate normally by following the operating instructions, adjust only those controls that are covered by the operating instructions as an improper adjustment of other controls may result in damage and will often require extensive work by a qualified technician to restore the equipment to its normal operation.
- E. If the equipment has been dropped, or the cabinet damaged.
- F. When the equipment exhibits a distinct change in performance —this indicates a need for service.

14. Replacement Parts

When replacement parts are required, be sure the service technician has used replacement parts specified by the manufacturer or that have the same characteristics as the original part. Unauthorized substitutions may result in fire, electric shock or other hazards.

15. Safety Check

Upon completion of any service or repairs to this equipment, ask the service technician to perform safety checks to determine that the equipment is in proper operating condition.

16. Field Installation

This installation should be made by a qualified service person and should conform to all local codes.

17. Correct Batteries

Warning: Risk of explosion if battery is replaced by an incorrect type. Dispose of used batteries according to the instructions.

18. Tmra

A manufacturer's maximum recommended ambient temperature (Tmra) for the equipment must be specified so that the customer and installer may determine a suitable maximum operating environment for the equipment.

19. Elevated Operating Ambient Temperature

If installed in a closed or multi-unit rack assembly, the operating ambient temperature of the rack environment may be greater than room ambient. Therefore, consideration should be given to installing the equipment in an environment compatible with the manufacturer's maximum rated ambient temperature (Tmra).

20. Reduced Air Flow

Installation of the equipment in the rack should be such that the amount of airflow required for safe operation of the equipment is not compromised.

21. Mechanical Loading

Mounting of the equipment in the rack should be such that a hazardous condition is not caused by uneven mechanical loading.

22. Circuit Overloading

Consideration should be given to connection of the equipment to supply circuit and the effect that overloading of circuits might have on over current protection and supply wiring. Appropriate consideration of equipment nameplate ratings should be used when addressing this concern.

23. Reliable Earthing (Grounding)

Reliable grounding of rack mounted equipment should be maintained. Particular attention should be given to supply connections other than direct connections to the branch circuit (e.g., use of power strips).

Hardware Overview - Shadow Series (4-Ch.)

FRONT

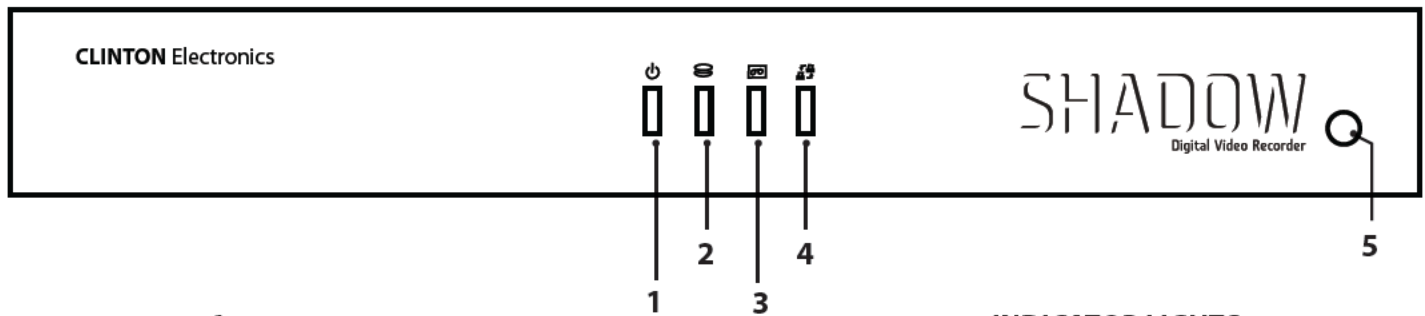

SIDE

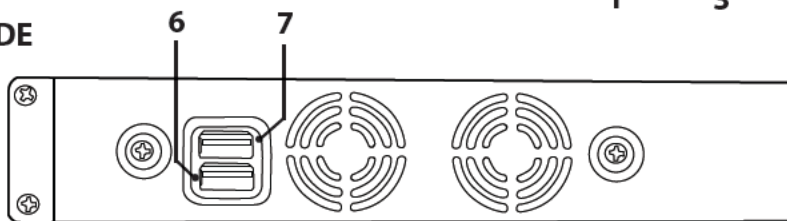

INDICATOR LIGHTS

1. Power Indicator Light
2. HDD Indicator Light
3. Recording Indicator Light
4. Network Indicator Light
5. IR Remote Receiver

USB CONNECTIONS

6. USB Backup Drive Input: Only for firmware upgrade or data backup
7. USB Mouse Input: Only for mouse

REAR

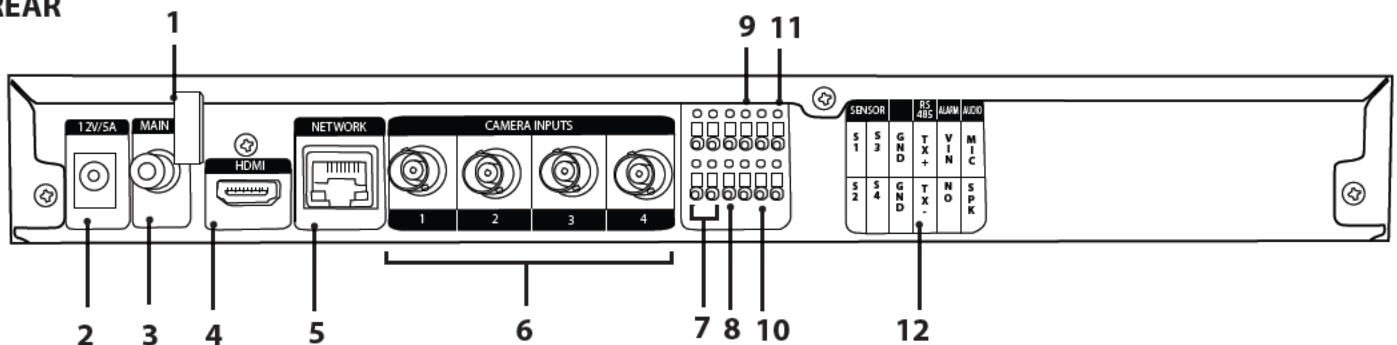

POWER

1. Cord Retaining Clip
2. Power Cord Connection

VIDEO / NETWORK

3. Main Out - RCA
4. HDMI Out
5. RJ45 Network Connection
6. Camera Input (x4)

OTHER CONNECTIONS

7. Sensor Connections
8. Ground Connections
9. RS485 Connections
10. Alarm Out Connections
11. Audio Connections
12. Connection Diagram

Hardware Overview - Shadow Series (8 & 16-Ch.)

FRONT

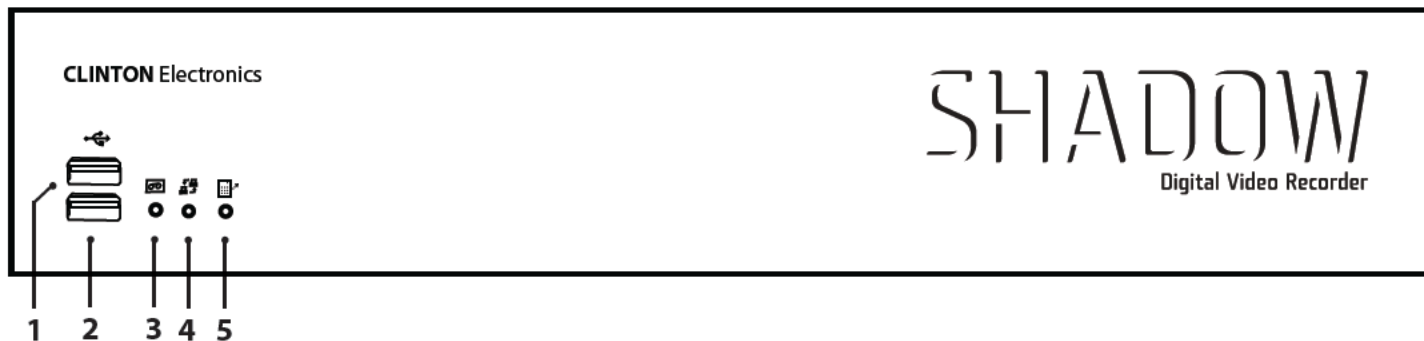

USB CONNECTIONS

1. USB Backup Drive Input: Only for firmware upgrade or data backup
2. USB Mouse Input: Only for mouse

INDICATOR LIGHTS

3. Recording Indicator Light
4. Network Indicator Light
5. IR Remote Receiver

REAR

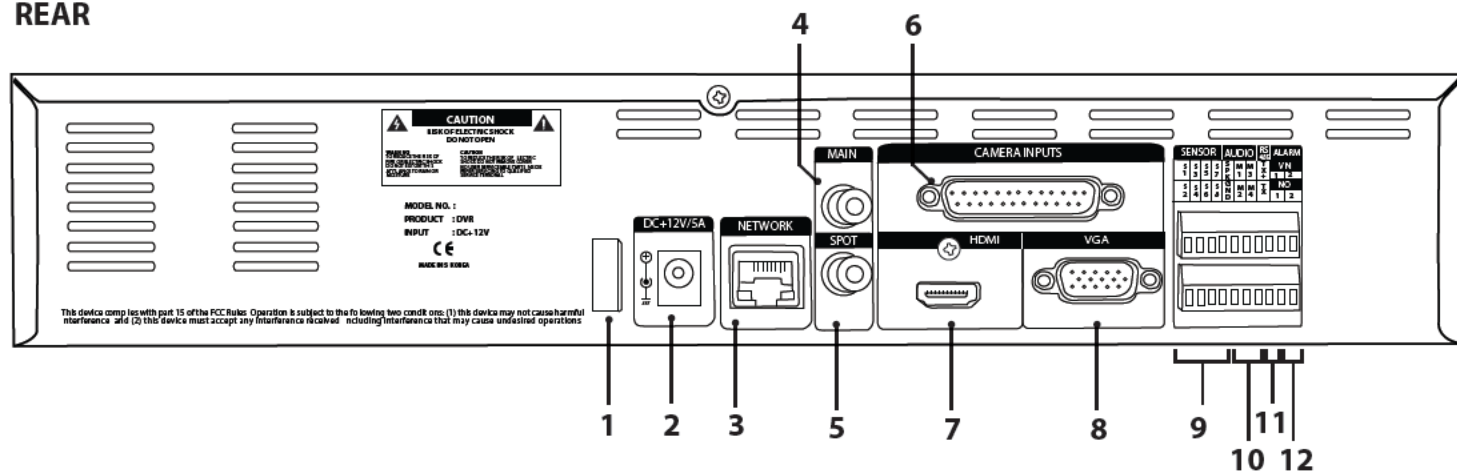

POWER

1. Cord Retaining Clip
2. Power Cord Connection

VIDEO / NETWORK

3. RJ45 Network Connection
4. Main Out
5. Spot Out - No OSD controls are available with Spot Out
6. Camera Input Plug (x8, x16 depending on DVR model)
7. HDMI Out
8. VGA Out

OTHER CONNECTIONS

9. Sensor Connections
10. Audio Connections
11. RS485 Connections
12. Alarm Connections

Hardware Overview - Pro Series

FRONT

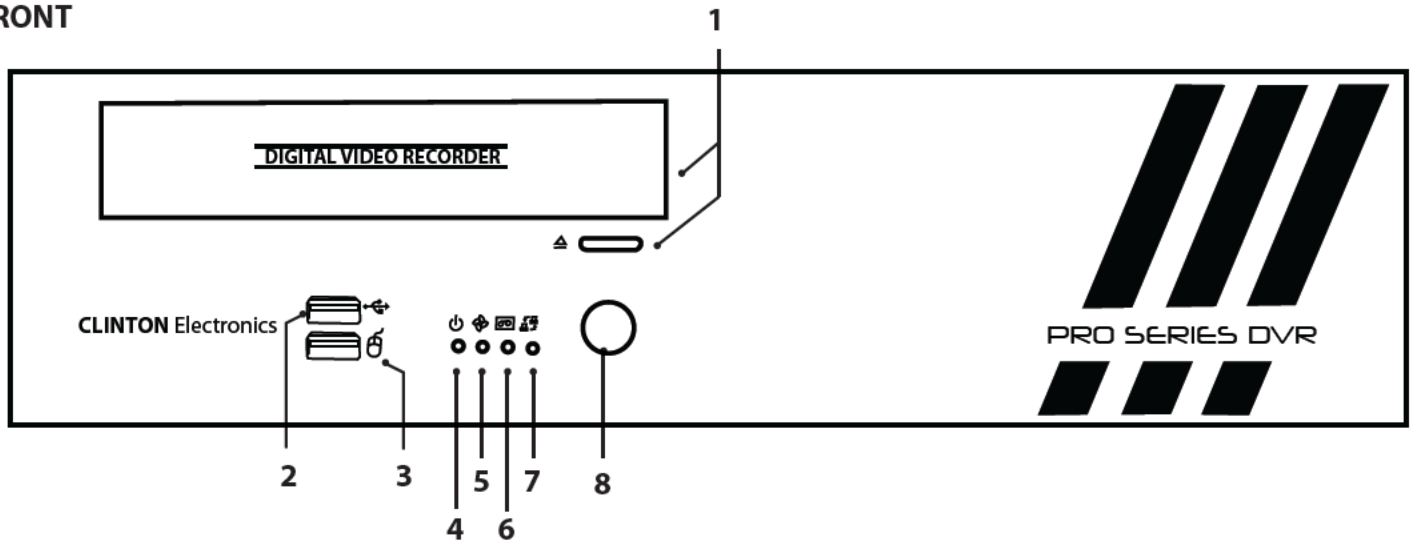

OPTICAL DRIVE

1. CD/DVD Disk Drive and Eject Button

USB CONNECTIONS

2. USB Backup Drive Input: Only for firmware upgrade or data backup
3. USB Mouse Input: Only for mouse

INDICATOR LIGHTS

4. Power Indicator Light
5. Internal Fan Indicator Light
6. Recording Indicator Light
7. Network Indicator Light
8. IR Remote Receiver

REAR

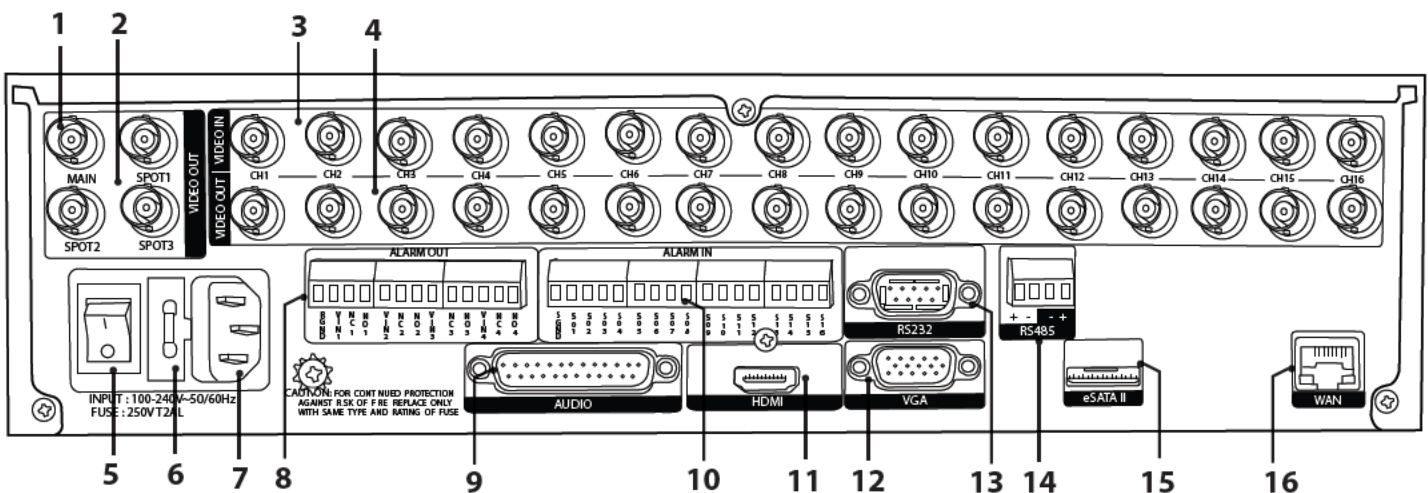

BNC

1. Main Out
2. Spot Out (x3)- No OSD controls are available with Spot Out
3. Camera Input (x8 or x16 depending on DVR model)
4. Loop Out (x8 or x16 depending on DVR model)

POWER

5. Power Switch
6. Fuse Holder (T2AL250VP)- Spare Fuse Provided in holder
7. Power Cord Connection

OTHER CONNECTIONS

8. Alarm Out Connections
9. Audio Connection
10. Alarm Input Connections
11. HDMI Output
12. VGA Output
13. RS232 Plug Connection
14. RS485 Connections
15. eSATA connection
16. RJ45 Network Connection

Hardware Overview - HD Series

FRONT

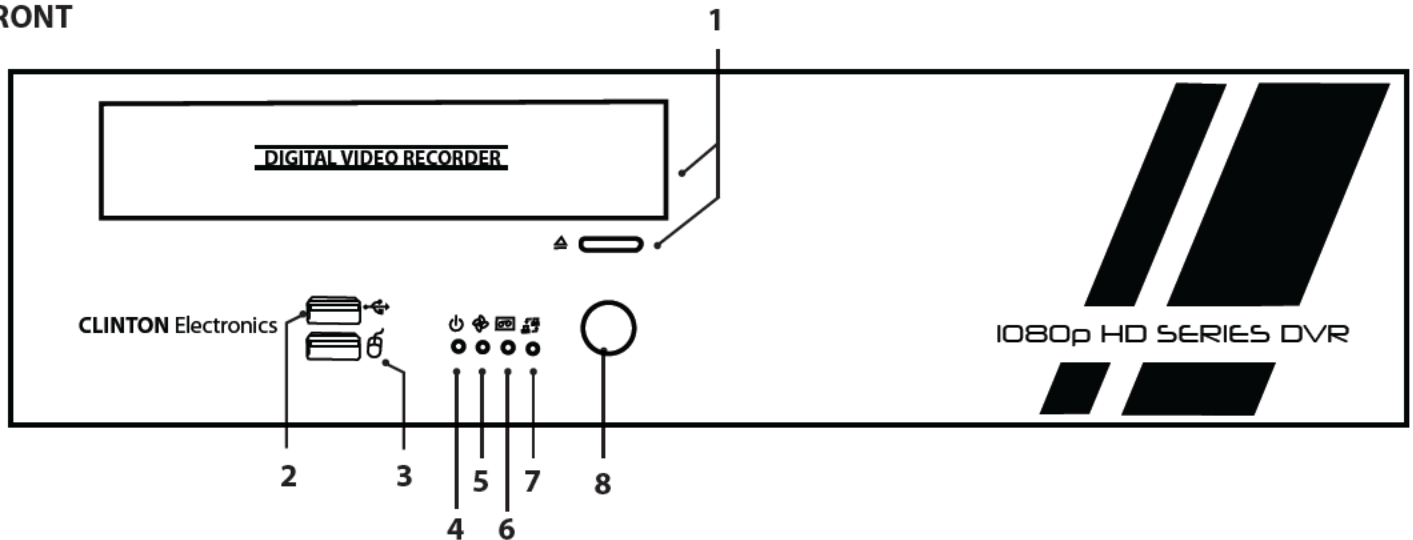

OPTICAL DRIVE

1. CD/DVD Disk Drive and Eject Button

USB CONNECTIONS

2. USB Backup Drive Input: Only for firmware upgrade or data backup
3. USB Mouse Input: Only for mouse

INDICATOR LIGHTS

4. Power Indicator Light
5. Internal Fan Indicator Light
6. Recording Indicator Light
7. Network Indicator Light
8. IR Remote Receiver

REAR

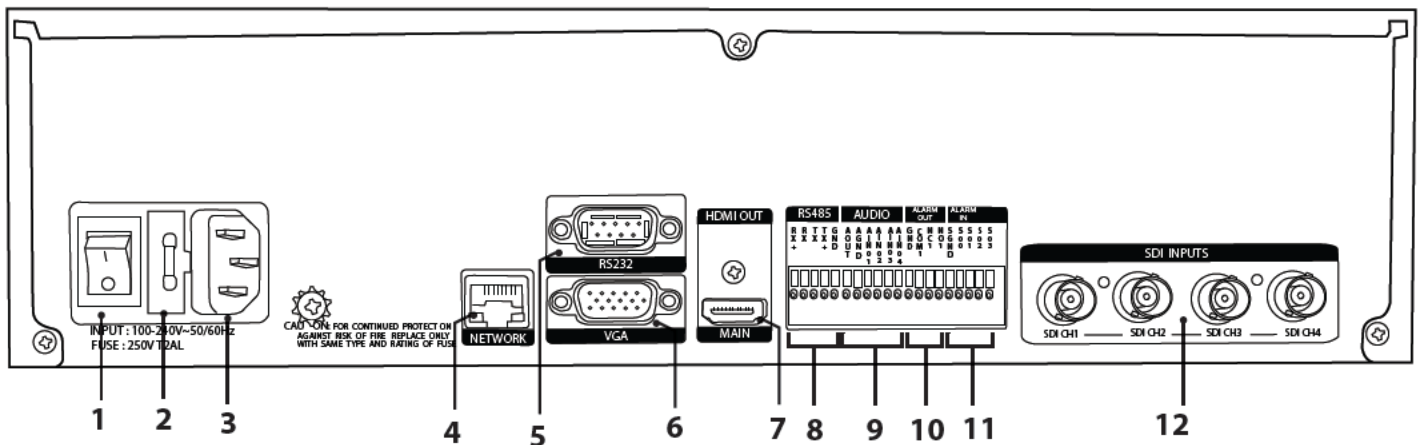

POWER

1. Power Switch
2. Fuse Holder (T2AL250VP)- Spare Fuse Provided in holder
3. Power Cord Connection

VIDEO / NETWORK

4. RJ45 Network Connection
5. RS232 Plug Connection
6. VGA Output
7. HDMI Output

OTHER CONNECTIONS

8. RS485 Connections
9. Audio Connections
10. Alarm Out Connections
11. Alarm Input Connections

BNC CONNECTIONS

12. SDI BNC Inputs (x4)

Remote Control Overview

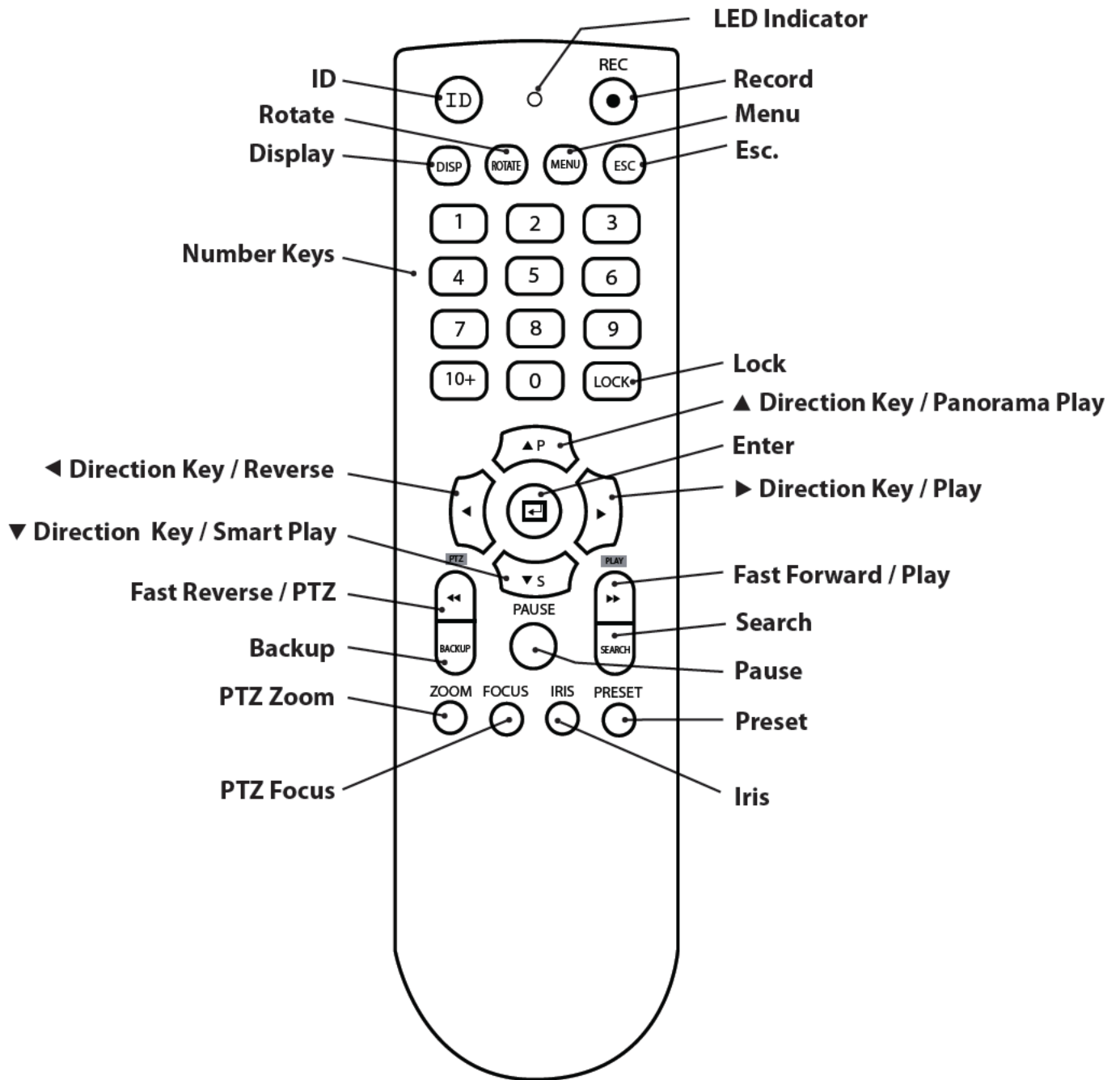

ID: Two digit remote control code from 0 (default) to 19.

Hold down ID and press 01 to change ID to 1.

Rotate: Rotate the image on the screen

Display: Cycle through the various heads-up display layouts

Number Keys: Use to select a specific camera number quickly

Left Direction Key / Reverse: Left arrow / Reverse

Down Direction Key / "S": Down arrow / Smart Play

Fast Reverse / PTZ: Quick reverse search / Open PTZ menu

Backup: Open manual backup menu

PTZ Zoom: Zoom mode when PTZ is connected

PTZ Focus: Focus mode when PTZ is connected

LED Indicator: Illuminates red when a button is pressed

Record: Manual record

Menu: Access the menu screen

Esc: Backs out of current selection

Lock: Quick User/Admin Logout

Up Direction Key / "P": Up arrow / Panorama Play

Enter: Enters the selected menu item

Right Direction Key / Play: Right arrow / Play

Search: Open search menu

Pause: Pause live or recorded footage

Preset: Cycle through PTZ presets when PTZ is connected

Iris: Iris mode when PTZ is connected

Live View Screen Layout

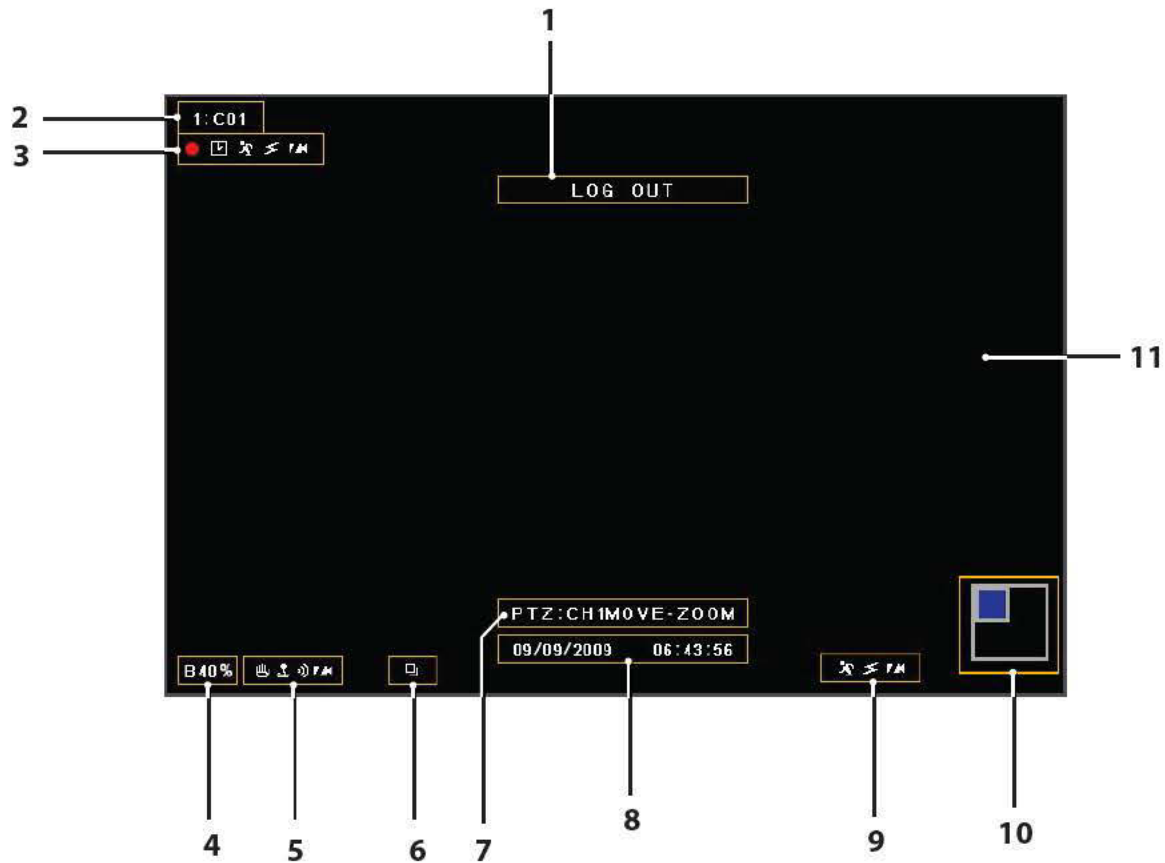

SCREEN AREA LEGEND

1. Execution Information Message
2. Camera Name
3. Record Status Icon-
 - Record Icon (Red):** Shows when recording is active within the live screen.
 - Time Icon:** Shows when time (schedule) record mode is active.
 - Motion Icon:** Shows when motion occurs.
 - Sensor Icon:** Shows when the external sensor is triggered.
4. Backup Progress Status %
5. Current Channel Information Icon-
 - Video-Loss Icon:** Shows when no video input is sensed.
 - Audio Icon:** Shows when audio occurs within the live screen.
 - Freeze Icon:** Shows when live view is paused.
 - PTZ Icon:** Shows when in PTZ mode.
6. Sequence Icon- When screen is rotated continuously
7. PTZ Control Information
8. Current Date and Time
9. Current Event Information
10. Zoom 2x / 4x Location
11. Live Screen Area

Top & Bottom Menu

Top Menu

In the live screen, press the up button on the remote control, or move the mouse cursor over the top area of the screen. The top menu will automatically appear.

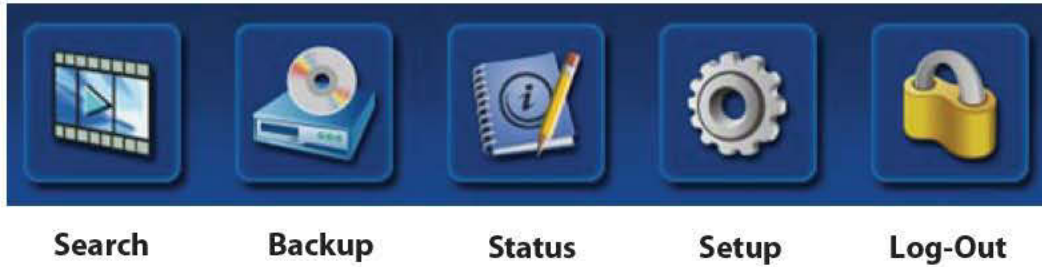

Bottom Menu

In the live screen, press the down button on the remote control, or move the mouse cursor over the bottom area of the screen. The bottom menu will automatically appear.

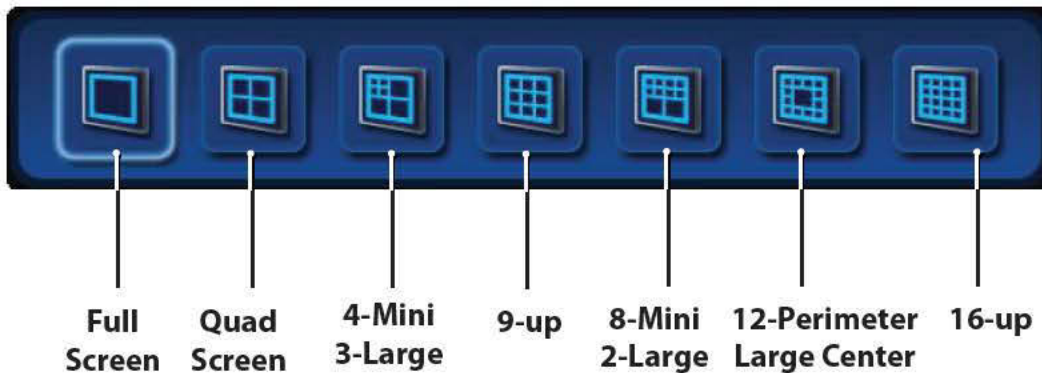

Camera Menu

Camera Menu

In the live screen, right-click the mouse button over the camera you would like to adjust setting for. With the remote control, press the *ENTER* button to bring up the pink-frame channel selector. Press the *ENTER* button again to bring up the menu for the selected channel.

From this menu you can access the adjustment menu for the selected camera channel.





CAMERA MENU

Adjustment: Adjust brightness, contrast, saturation, and hue for live or recording view.

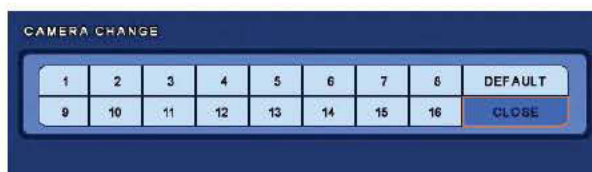
Cameo Change: Swap the position of the selected camera to the position of another camera.



Playback: Playback the last recording for the camera.

Freeze: Freezes the live screen. A  icon will be present within the channel's frame when image is in freeze mode. To unfreeze, select *FREEZE* again under the menu. Cameras will unfreeze when cameras are swapped positions, cameras are attached or detached from the DVR, or other actions are executed. (The  icon may remain on screen when this happens- To remove, select *FREEZE* again from the menu).

Freeze All: Freezes all live camera images. A  icon will be present when image is in freeze mode. To unfreeze, select *FREEZE ALL* again under the menu.

Sequence: Cycle through live screen channels.

Cameo Sequence: Cycle through live attached camera channels. *NOTE:* All screens except 16-channel screen will sequence any channel selected with cameras not shown on screen. Must have more cameras connected than are shown on the screen.

Page Sequence: Cycle through all channels (regardless of camera signal). *NOTE:* 1, 4, 9 camera screens only.

Camera Menu

PTZ: Select to control an attached PTZ camera. A PTZ camera must be connected in order to access this menu item. The PTZ icon  will appear in the lower left corner of the screen when within PTZ mode. The following will appear on the bottom center of the screen after selecting PTZ from the main menu.

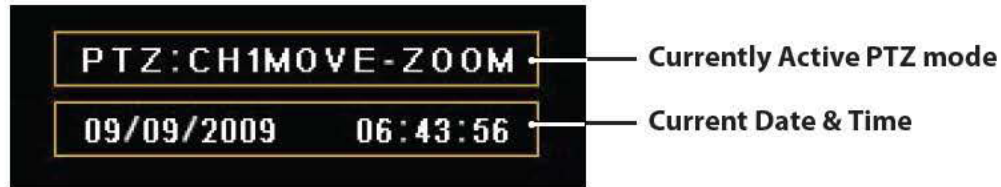

Using Mouse: Right clicking the mouse button will bring up the following control screen for Menu, Zoom, Focus, and Iris controls. Left click on the buttons to adjust your PTZ camera.



Using Remote Control:

Press the enter button when the PTZ selection is highlighted on the camera menu.

Menu: In PTZ mode, press the Menu button.

Pan & Tilt: In PTZ mode, press the arrow buttons.

Zoom: In PTZ mode, press the following:

Zoom In- Fast Reverse Button

Zoom Out- Fast Forward Button

Focus: In PTZ mode, press the Focus button, then the following:

Wide- Fast Reverse Button

Tele- Fast Forward Button

Iris: In PTZ mode, press the Iris button, then the following:

Open- Fast Reverse Button

Close- Fast Forward Button

Camera Menu

PTZ MENU

Speed Setup: Set the PTZ camera speed (1 to 8).

Preset Setup: Set the preset position. If the position setup is saved, PTZ camera will be directed to the set position by preset number.

Preset Tour: 6 different preset lists can be created. If the created preset lists are set to "ON", PTZ will run preset tour.

Pattern Setup: Pattern can be created by movement, zoom, focus, and iris. After pressing the BEGIN button, adjust the PTZ camera position or zoom and then press the END button. All directions (up, down, left, and right), zoom and iris settings are recorded. If using Clinton PTZs- set to Pelco Protocol to make this function available.

Pattern Tour: PTZ camera moves according to the saved pattern.

Auto Focus: Turn On/Off auto focus. This feature is not available when using Clinton PTZ cameras.

Power: Turn On/Off power. This feature is not available when using Clinton PTZ cameras.

Light: Turn On/Off light. This feature is not available when using Clinton PTZ cameras.

OSD Menu: Turn On/Off OSD. This feature is not available when using Clinton PTZ cameras.



Zoom x 2: 2x zoom in on the currently selected channel. Press the arrow keys on the remote control, or left-click using the mouse on the side of the screen you would like to shift the image. Right click the mouse to exit zoom feature.
NOTE: A single channel must be selected in order to access this menu item.

Zoom x 4: 4x zoom in on the currently selected channel. Press the arrow keys on the remote control, or left-click using the mouse on the side of the screen you would like to shift the image. Right click the mouse to exit zoom feature.
NOTE: A single channel must be selected in order to access this menu item.

Audio On: Turn the audio on for the selected channel. This will only be used when an audio device is attached to the associated channel.

Top Menu - SETUP

Top Menu

In live screen, move the mouse cursor over the top portion of the screen, or press the ▲ button on the remote control to show the menu. Click on an icon to enter the menu. Login may be necessary.

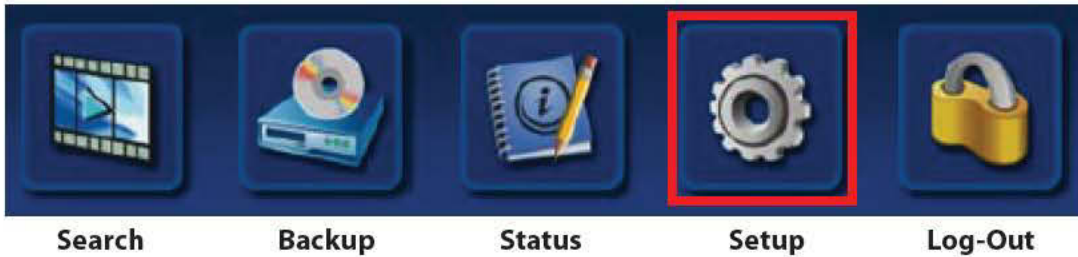

Login Box

Before you can access any controls, you must first login with your user ID and password. The default ID is "root" and the default password is "1111". Click the check-mark with your mouse cursor or press the enter button on the remote to proceed.



Default Password: 1111

The ✓ icon Accepts a setting.
The ✗ icon Cancels out of the selection.

Log-Out

Select the Log-Out selection to exit your account. User may be automatically logged out after a 15 minute period of inactivity.



Setup Menu

After successful login you will have access to the following features within the Setup menu selection.



SETUP / General / System

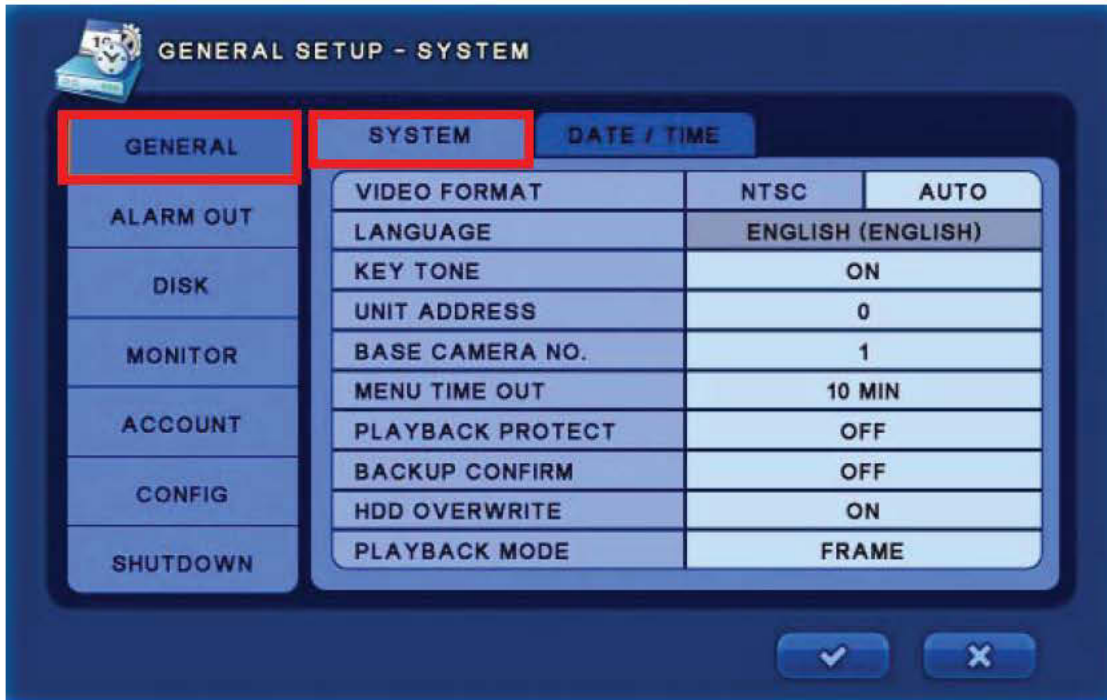

• **Video Format:** Select the camera type: (NTSC / PAL). With "Auto" selected, the DVR will recognize the camera type automatically.

• **Language:** Select the language.
(English, German, French, Spanish, Japanese, Chinese, Italian, Russian, Dutch, Korean)

• **Key Tone:** Turn on/off the buzzer key tone.

• **Unit Address:** Set the DVR's ID. This ID can be used when multiple DVRs are in the same location to control the DVRs individually.

• **Base Camera No:** Set the beginning number of a camera. This can be useful to determine which camera is shown on-screen when multiple DVRs are being used.

Example: If set to "17", the first camera number will be 17.

If 16 cameras are attached, the camera numbers will range from 17 to 32.

• **Menu Timeout:** Set the length of time the menu will show on-screen before it disappears.

• **Playback Protect:** Prohibit the playback of passed data. (Select from 0-99 days)

Example: If set to 3 days, the DVR will only save 3 days worth of data before it is overwritten.

• **Backup Confirm:** Enable this setting to require admin login before you can backup.

• **HDD Overwrite:** Select on/off to overwrite data on Hard Disk.

Note: If set to [OFF], recording will be stopped automatically when disk is full.

• **Playback Mode:** This is playback quality option if the resolution is set D1.

[FRAME] : Played by original.

[FIELD] : Played by Deinterlace.

SETUP / General / Date & Time

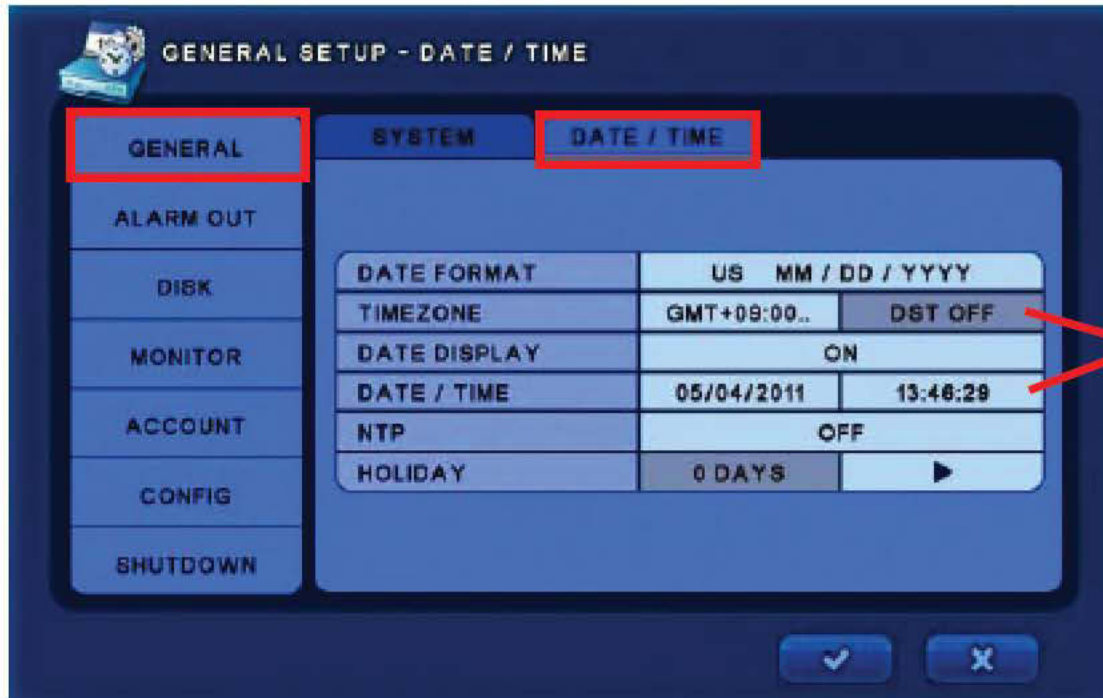

Date / Time:

- **Date Format:** Select the date format from the following: (YY/MM/DD) (MM/DD/YY) (DD/MM/YY)
- **Time zone:** Select the time zone and daylight savings time. DST will be automatically set to OFF if you select a time zone which doesn't use DST.
Note: This information will be automatically synced when connected to the internet. See NTP setting below.
- **Date Display:** Select ON for the date & time to be shown on the live view screen.
- **Date / Time:** Change the date and time. *Note: This information will be automatically synced when connected to the internet. See NTP setting below.*
- **NTP:** Select the usage of the NTP (Network Time Protocol). With NTP the DVR is synchronized with NTP server and will automatically obtain the correct time. The default server is [pool.ntp.org]. User can input an alternate server if desired.
 - Auto Sync:** Synchronize automatically every day. *Note: Before you can select this option, you must first select "Sync Now".*
 - Sync Now:** Synchronize immediately.
- **Holiday:** Add or Delete a holiday. You can choose holiday recording parameters in the "Schedule Record" menu.

SETUP / General / Alarm Out

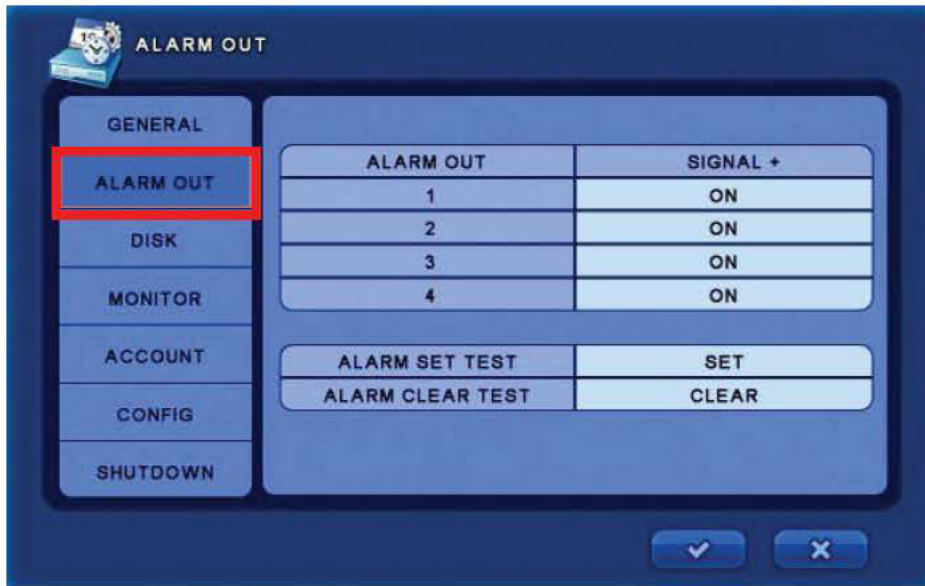

- **Alarm Out:** Column shows alarm outputs listed 1-4.
- **Signal+:** Select on / off to enable or disable the corresponding alarm channel.
- **Alarm Set Test:** Select to test the alarm device. Selecting SET will activate the connected alarm device for each output set to "ON".
- **Alarm Clear Test:** Select to cancel the activated alarm device. Selecting CLEAR will cancel the alarm for the activated device in the "Alarm Set Test".

SETUP / General / Disk Setup

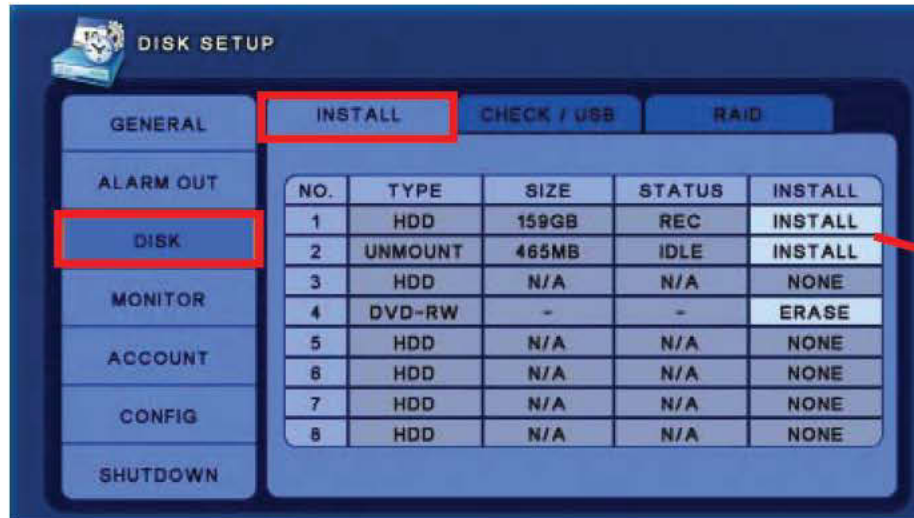

Select "Install" to format a newly installed HDD.

Note: doing so will delete all data from the device.

Install

The install menu will display as a list of numbers which correspond to the type of device, the size of the device, and the status for each device.

Selecting a highlighted type will display the information on the drive which includes the Vendor, Model number, Serial Number, and Status of the device.

- **Install:** Select to install a new device for the first time. You may also use this selection to reformat an already installed device. Doing so will erase all currently stored data on the device.
- **Erase:** Erases the data on a re-writable disk.

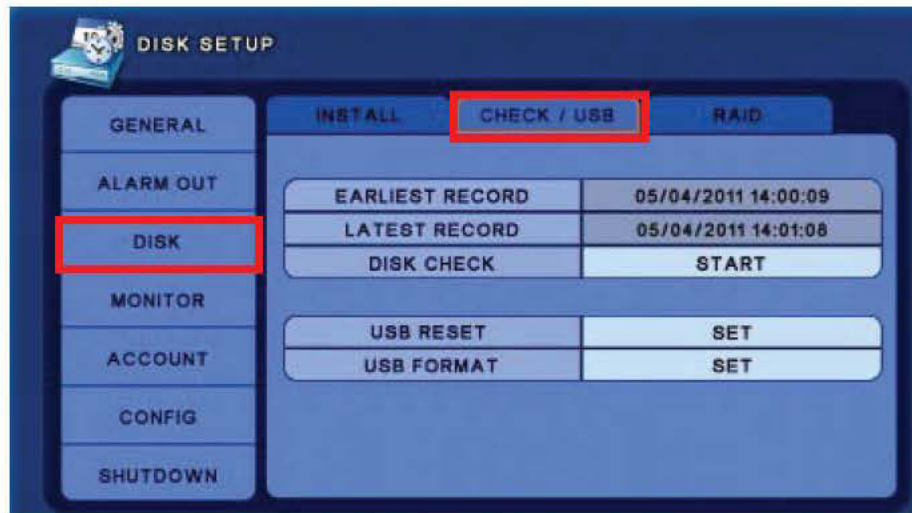

Check / USB

- **Earliest Record:** Shows the earliest recorded data information.
- **Latest Record:** Shows the most current recorded data information.
- **Disk Check:** Check the data from the earliest recorded data to the latest. This checks for errors in the HDD.
- **USB Reset:** Select SET to reset the USB connection.
- **USB Format:** Select to format an inserted USB device. NOTE: Doing so will erase all data on the device.

SETUP / General / Disk Setup / RAID

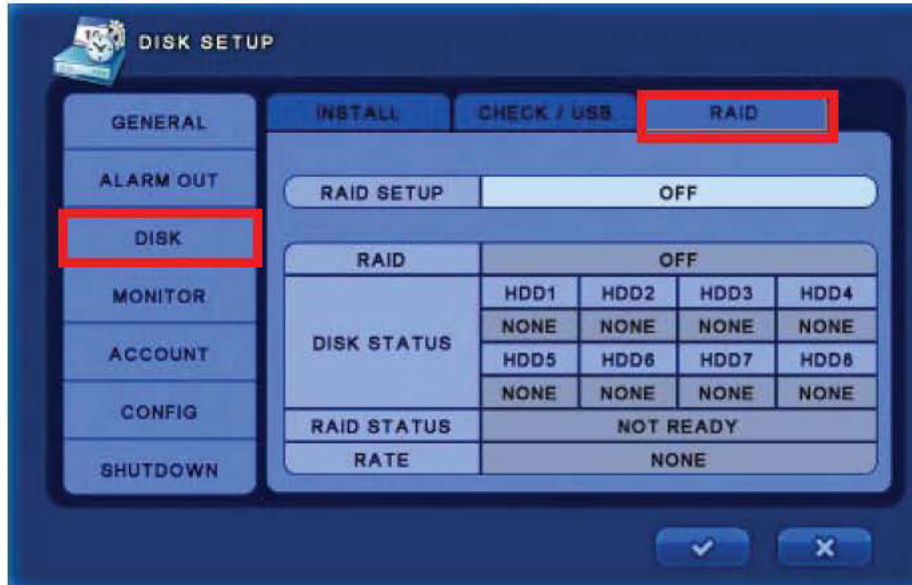

RAID

This feature is only available on Pro-Series DVRs.

- **RAID Setup:** Select to install a new device for the first time. You may also use this selection to reformat an already installed device. Doing so will erase all currently stored data on the device.
- **RAID:** Displays RAID level.
- **Disk Status:** Display disk status.
- **RAID Status:** Display RAID status.
- **Rate:** Display the progress during RAID setup.

WARNING !

- * **By the RAID level, a minimum of 2 hard drives should be installed.**
- * **The RAID HDD should be the same model as primary HDD.**
- * **Disk error can occur if RAID HDD brand or model is different from primary HDD.**

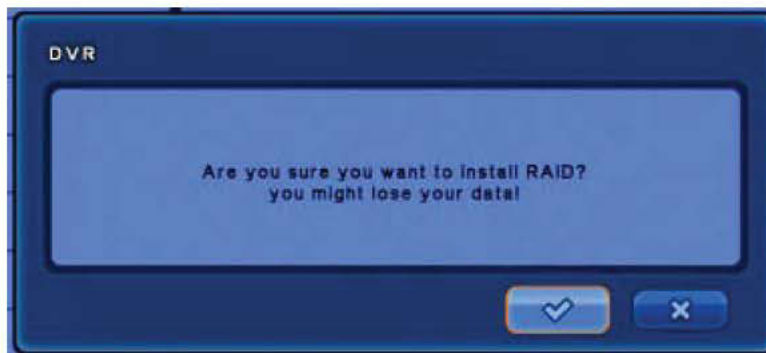

- You will see the above message when setting up RAID. Selecting will reboot the device.
- * **When RAID is built, all HDD data will be deleted. Backup data before initializing RAID build.**
Note: Reboot time is longer than normal boot time when initializing RAID. (About 5 minutes)

SETUP / General / Disk Setup / RAID

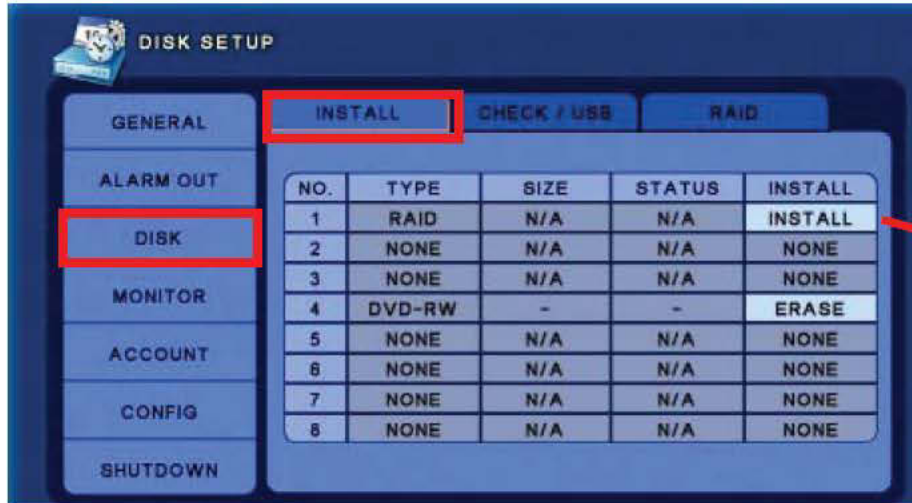

After build, the HDDs will show as a single RAID device in the install screen.

After the RAID is built, the type on the install tab will be changed to [RAID] and recognized as a single HDD. Supported RAID level is 0, 1, 5

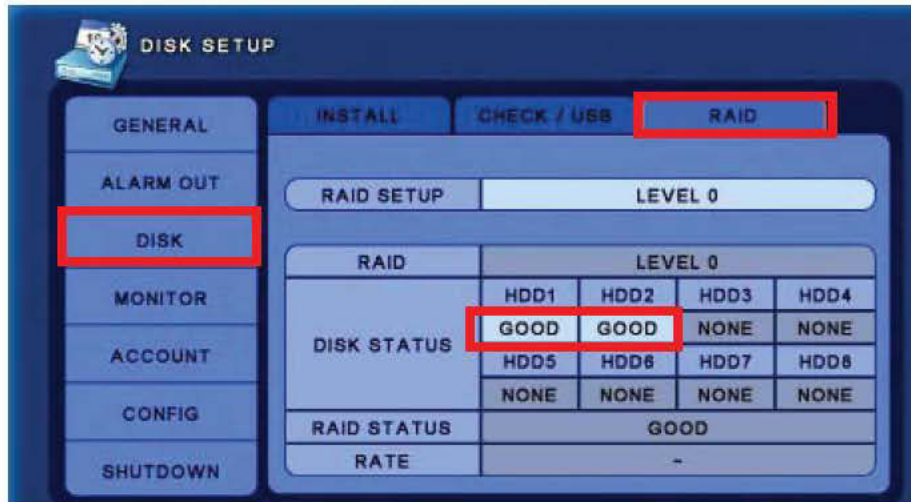

• **RAID 0:** Build time for RAID level 0 is about 5 minutes. The HDD status will show "GOOD" if the build has been successfully completed.

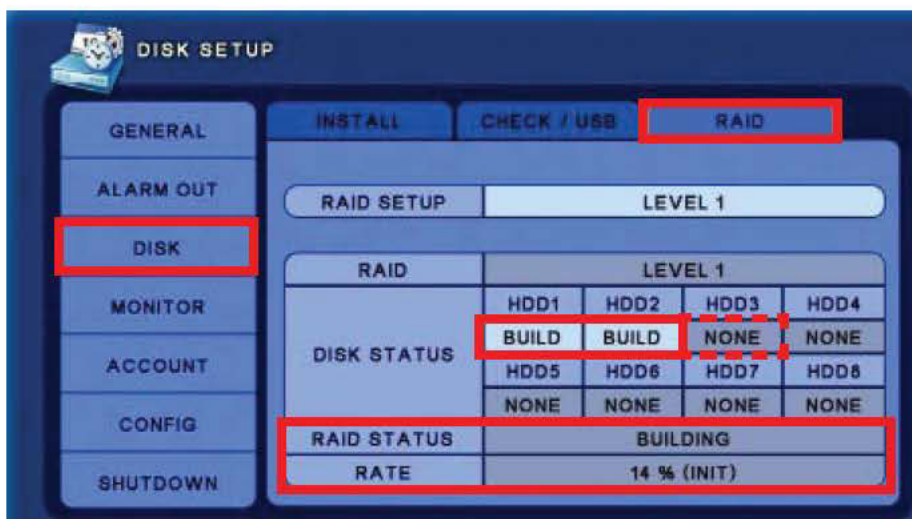

• **RAID 1 & RAID 5:** Build time for RAID level 1, and level 5 will range from 24 to 48 hours. You can check the build status under RAID Status, and Rate.

SETUP / General / Monitor

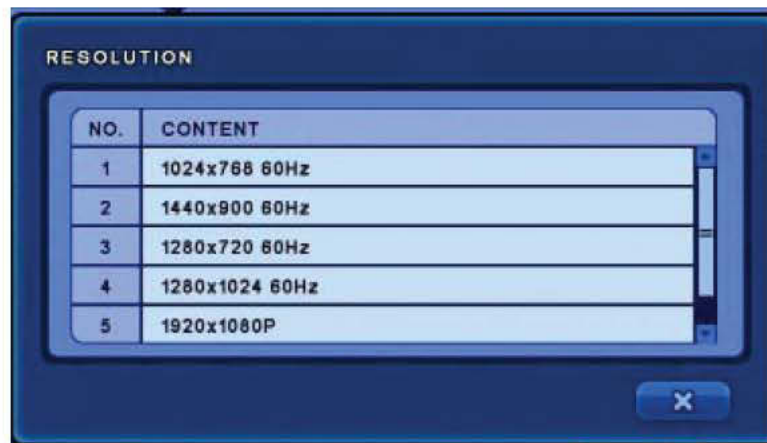
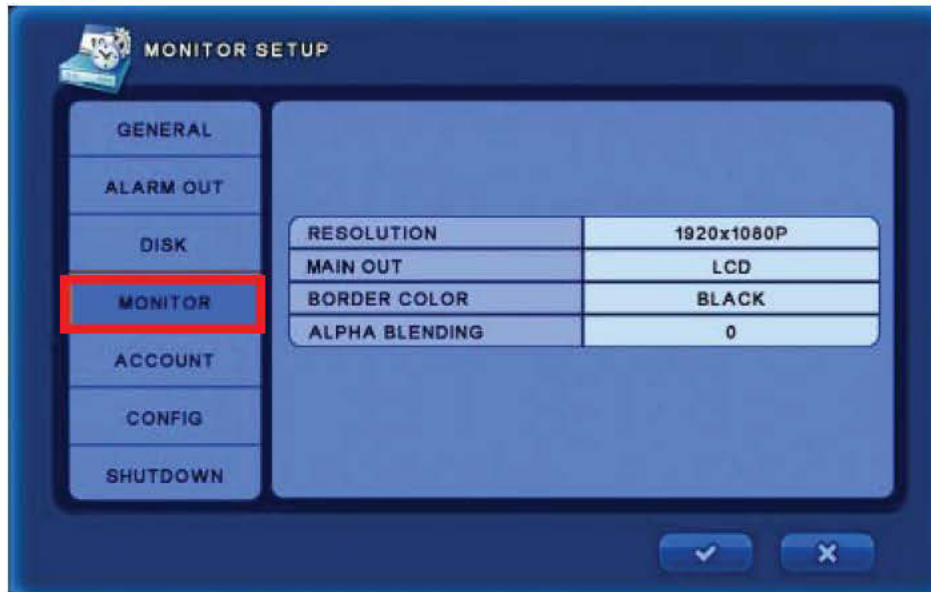

- **Resolution:** Select the resolution for the connected monitor.
- **Main Out:** Select main monitor type - LCD or CCTV.
NOTE: This option not available on Shadow Series.
- **Border Color:** Change the border color.
- **Alpha Blending:** Set the transparency of the OSD menus.

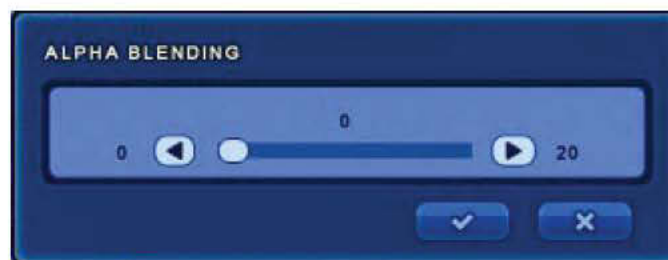

SETUP / General / Account

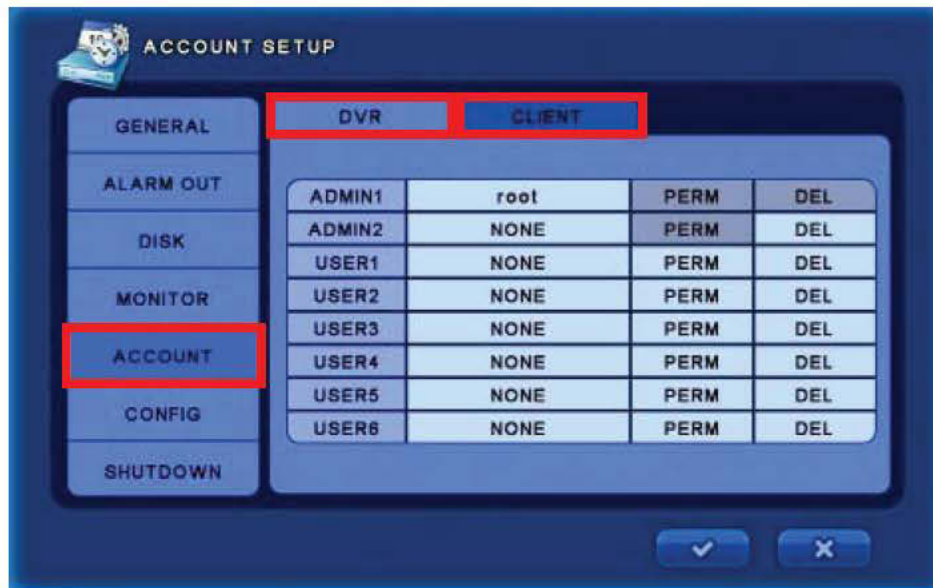

DVR & CLIENT:

Select the DVR tab to configure login settings at the DVR. Select the Client tab to configure login settings for network access.

- **Admin1:** Administrators will have complete access to all DVR features.
- **User:** General Users will have restricted access. They will not have access to menu features.

Add / delete any user and give permission freely.

When adding new user, input new password and confirm. When deleting a user, confirm again to complete.

NOTE: (Default ADMIN password is 1111), Initial user name can be modified but can not be deleted.

With the [PERM] menu, you can give permission to each user. (Playback, Backup, PTZ)

SETUP / General / Configuration

Setting up a configuration allows you to save all settings to the DVR. After you have set up the DVR, you can save the settings as a configuration. If something is changed in the future you can revert back to the original configuration. You can also quickly set up another DVR with the same settings by exporting the configuration to a CD or USB drive, and then importing to another DVR.

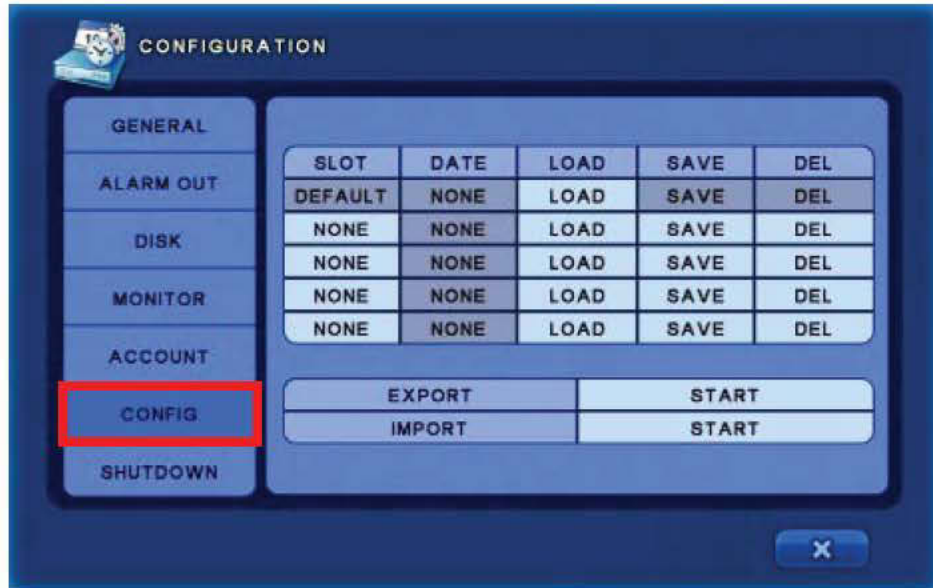

- **Slot:** Label the slot to load or save configuration.
- **Date:** Display the date the configuration was saved.
- **Load:** Load the saved configuration.
- **Save:** Save the current configuration.
- **Del:** Delete the configuration data on the Slot.
- **Export:** Export the current configuration to USB or DVD.
- **Import:** Import the configuration data from USB or DVD to the DVR. You can choose to load camera, recording, system, and/or network settings.



Import Screen



Export Screen



- **Restart:** Restart the DVR. This is typically done after a firmware update.
- **Shutdown:** Shutdown the DVR. This is the recommended way to safely power off the DVR. Flipping the power switch on the back of the DVR or disconnecting the power may result in damage to the hard drive.

SETUP / Camera / Camera

Within the Camera Menu you can access camera settings as well as adjust PTZ, Spot, Sequence and Private Zone Settings.



- **Camera Label:** Select the way in which you would like the camera label to be shown on the live screen. You can have each camera show the camera number [NUMBER], camera name [NAME], both of these by selecting [ALL], or to display none of these by selecting [OFF].



Virtual Keyboard

- **Night Mode:** Auto mode will automatically reduce recording file size at nighttime because of camera noise.
- **Name:** Change the camera name. (The virtual keyboard will appear when a camera's name is selected.)
- **Install:** You can choose to have a camera show as installed or uninstalled. When "Install+" is set to [OFF], the camera for the selected channel will not be recorded or show on screen.
- **Hidden:** You can choose to hide a selected channel on live view. When hidden the camera will not show on live view, but the camera's signal will continue to record as normal.

SETUP / Camera / PTZ

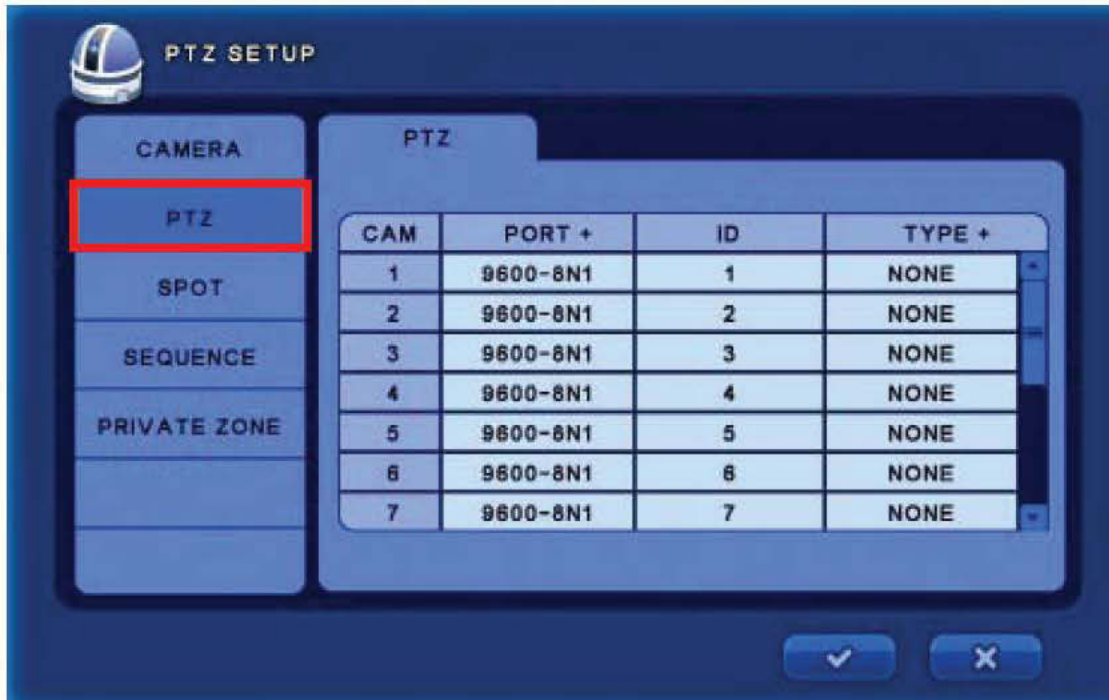

PTZ

- **Port:** Enter the Baud Rate parameters for the attached PTZ camera.
- **ID:** Select an ID number for the associated PTZ camera.
- **Type:** Select the PTZ type from a list of common PTZ protocols.

Note: The values that are entered into the above PTZ parameters will depend on the PTZ camera attached.

Note: Refer to the PTZ camera's manual for instructions on connecting to the RS-485 port.

SETUP / Camera / Spot

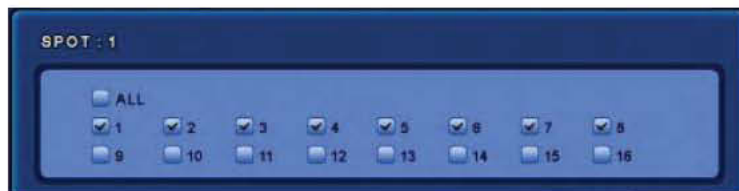

Spot Screen

- **Camera:** Select the camera(s) to display on the spot monitor.
NOTE: To enable multiple cameras to sequence on the spot monitor, you must set [SEQUENCE] to [ON].
- **Default:** Select the camera to display on spot monitor when sequence is off.
- **Split:** Select to have 1 or 4 cameras to display per screen. *NOTE: This option not available on Shadow Series.*
- **Sequence:** Select On/Off to enable/disable camera sequencing on the spot monitor.



Interval Screen

- **Interval:** Select the interval time before sequencing onto the next camera. 256 second max. (4min. 16sec.)
- **Popup:** Select On to enable pop-up screen when an event occurs.

Note: The same camera image cannot be displayed on each spot monitor.

SETUP / Camera / Sequence

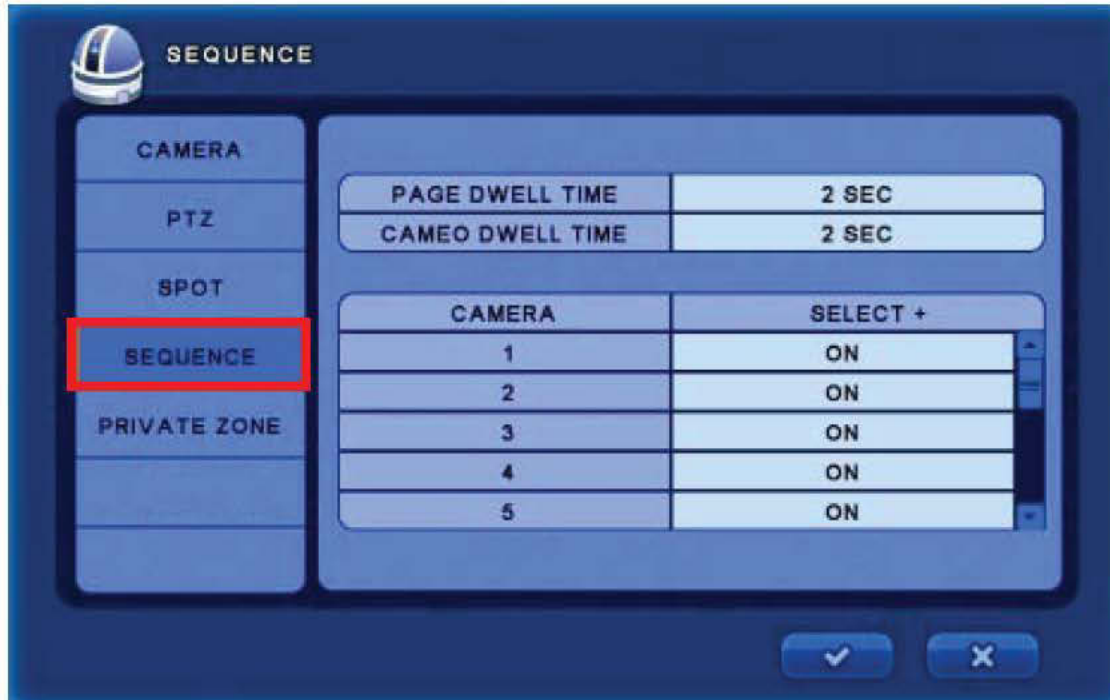

- **Page Dwell Time:** Select the dwell time before the sequence proceeds to the next page on the main monitor. Available on 1 / 4 / 9 camera screens.

- **Cameo Dwell Time:** Select the dwell time before the sequence proceeds to the next channel.
Note: For the cameo sequence- the selected camera is sequenced into the selected division screen, with all cameras not shown on the screen. Not available on 16 camera screen. Cameo sequence cameras can be turned on / off in the Select column. Camera image which is shown on other sections of the division screen are not sequenced.

SETUP / Camera / Private Zone

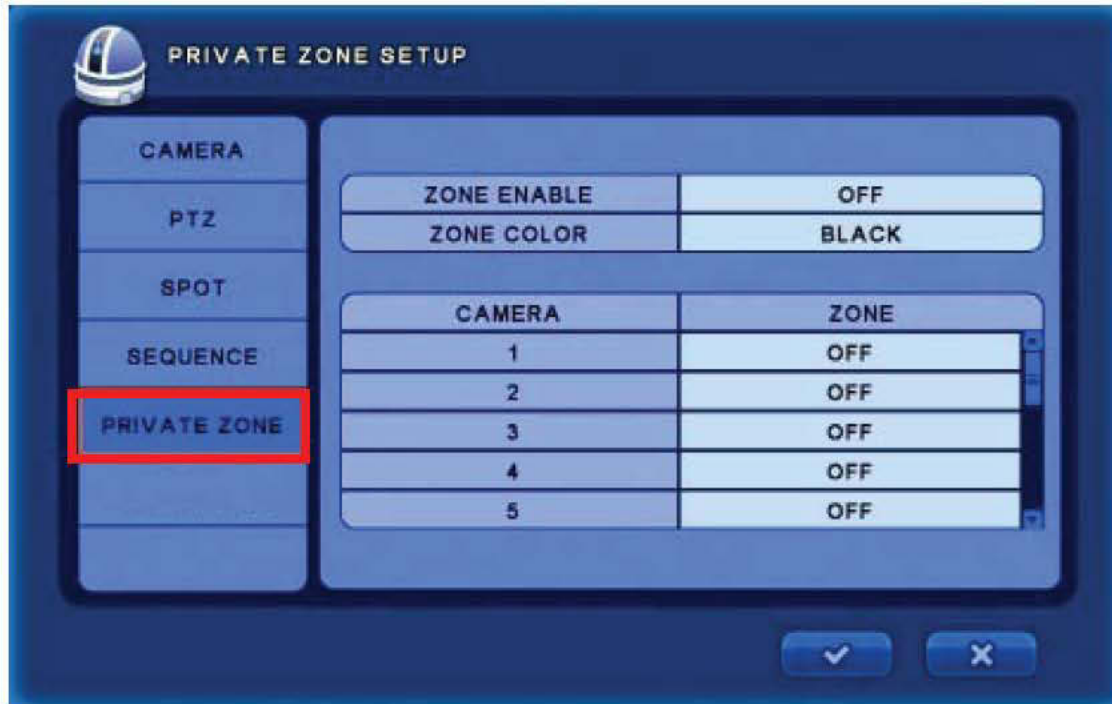

- **Zone Enable:** Select from Off, Live, or Live+Playback.
- **Zone Color:** Select the privacy zone color. (Blue, Black, White, Gray)
- **Zone:** Select the camera in which to apply the Privacy Zone. When a Zone is selected, the corresponding camera image will appear on screen. From here you can set the Privacy Zone as follows:

Move the cursor to the desired zone start point. Click and hold the left mouse button on a square to set a starting corner. Move the cursor to the desired opposite end corner and release the mouse button to define a block of cells.

Right-click the mouse to bring up the zone menu. Using this menu, a selected area can be deleted or saved, or you can return to the previous menu screen.

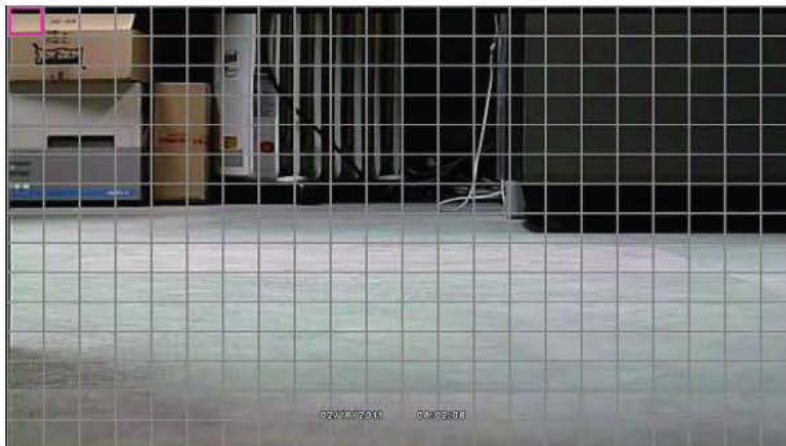

SETUP / Event / Motion Setup: Input

Within the Event Menu you can adjust settings for Motion, Alarm-In, Video Loss, System, and Display setup.



Top-Level Menu

Motion: Input

- **Active:** Select ON to activate the motion area.
- **Level:** Select the motion sensitivity level from low (1) to high (5).
- **Area:** Define motion areas by selecting individual cells or groups of cells.

Left click with the mouse, or press enter on the remote to select a cell.

Left click and drag the mouse cursor to select multiple cells.

To select multiple cells with the remote, press enter and use the arrow keys. Press enter again to confirm.

When done setting up motion cells, right click with the mouse, or press the **MENU** button on the remote to bring up selection options.

Tip:

To apply settings to all cameras simultaneously, make changes in the top-level menu.

Note:

To enable motion recording, continuous recording should be turned OFF. See page 41 for details.

SETUP / Event / Motion Setup: Action

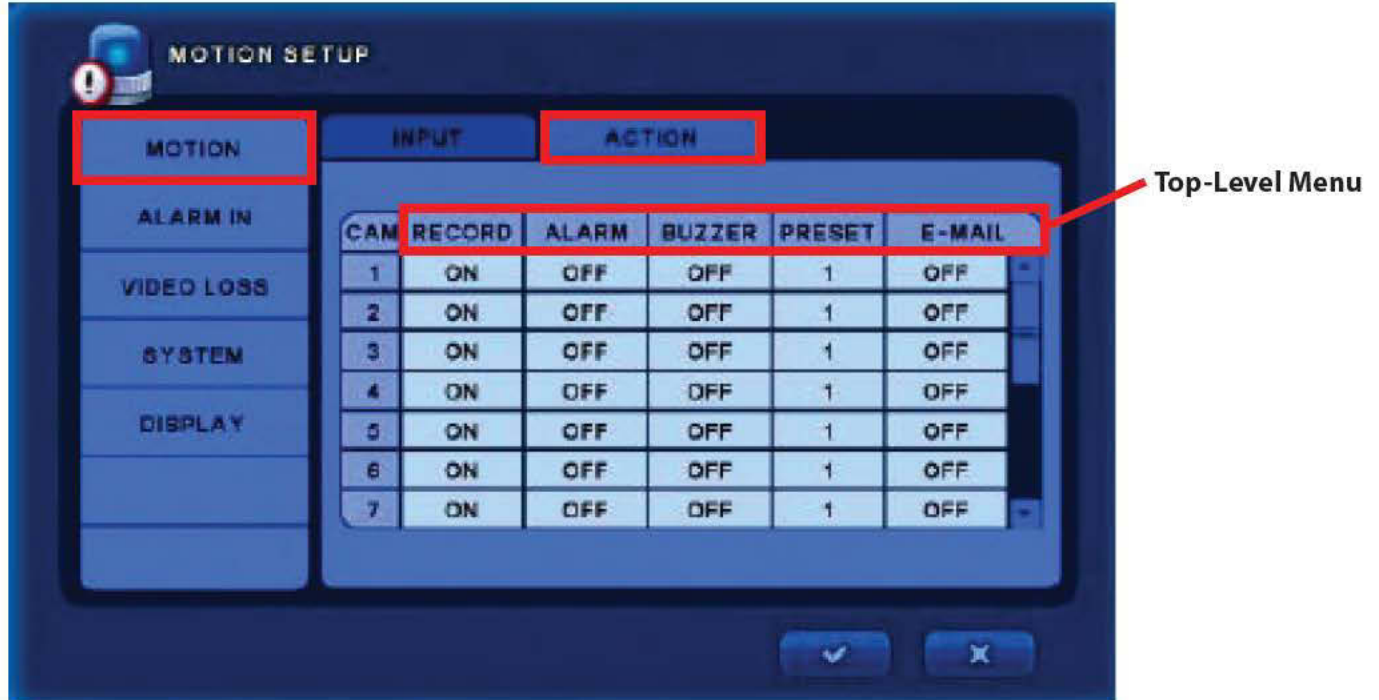

Motion: Action

- **Record:** You can enable a DVR channel to record when motion is sensed by a another camera. Select ON to activate the motion area.

The default setting is to only record the channel in which motion has occurred.

Example: Camera channel 1 will only record when camera 1 senses motion.

Select the "Default" option when under the top level menu to restore the default to each camera.



Motion Record Screen

- **Alarm:** Select ON to enable an externally attached alarm. You can also apply a delay before the alarm is triggered, and select the duration of the alarm (from 0-99 seconds).
- **Buzzer:** Select ON to enable an audible chime from the DVR when motion occurs.
- **Preset:** Set the preset number. When motion occurs, a PTZ camera will move to the preset position. For information on setting up PTZ presets see page 16.
- **E-mail:** Enabling this function will send an E-mail to the selected recipients when a motion event occurs.

SETUP / Event / Alarm In

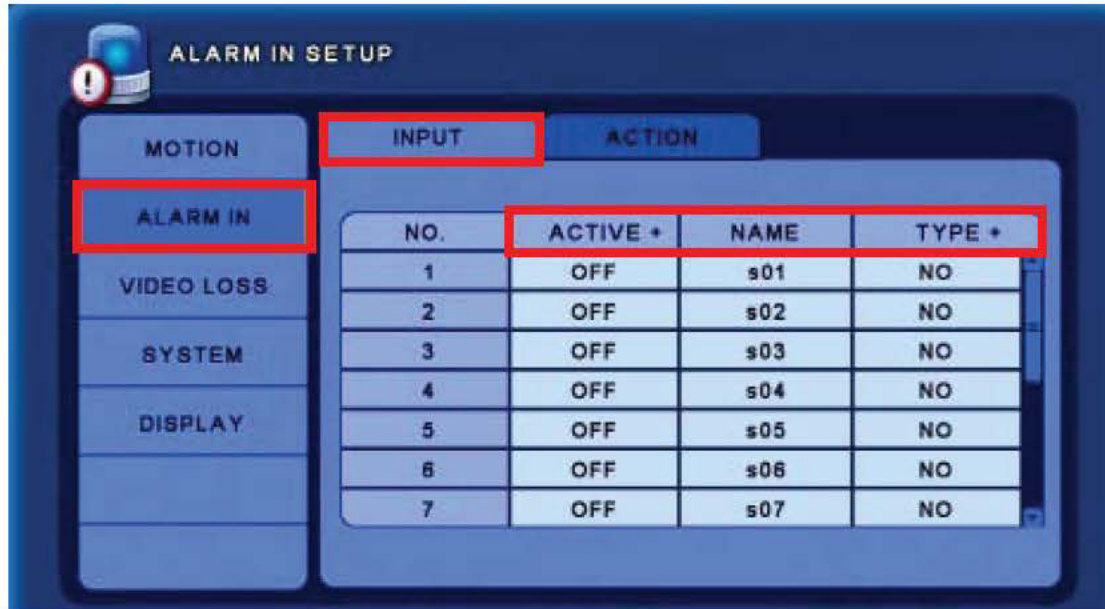

- **Active:** Select On/Off to activate alarm.
- **Name:** Input the desired alarm name.
- **Type:** Select the alarm type. (NO : Normally Open, NC : Normally Closed)

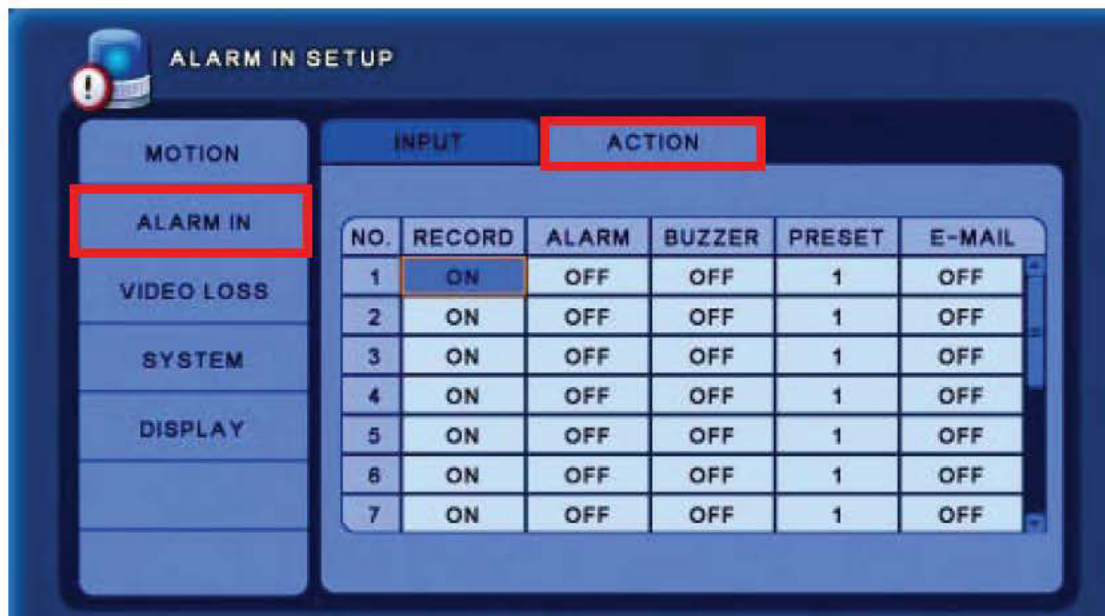

- **Record:** Set to On to record when the alarm input is triggered.
- **Alarm:** Select On/Off to enable or disable the selected alarm out.
- **Buzzer:** Select On to enable an audible chime from the DVR when alarm input is triggered.
- **Preset:** Set the preset number. (When alarm input is triggered, a PTZ camera will move to the preset position.)
- **Email:** Select On to receive an email notification when alarm input is triggered. Define email recipients in the following menu: Setup / Network / Email. See page 48 for details.

SETUP / Event / Video Loss

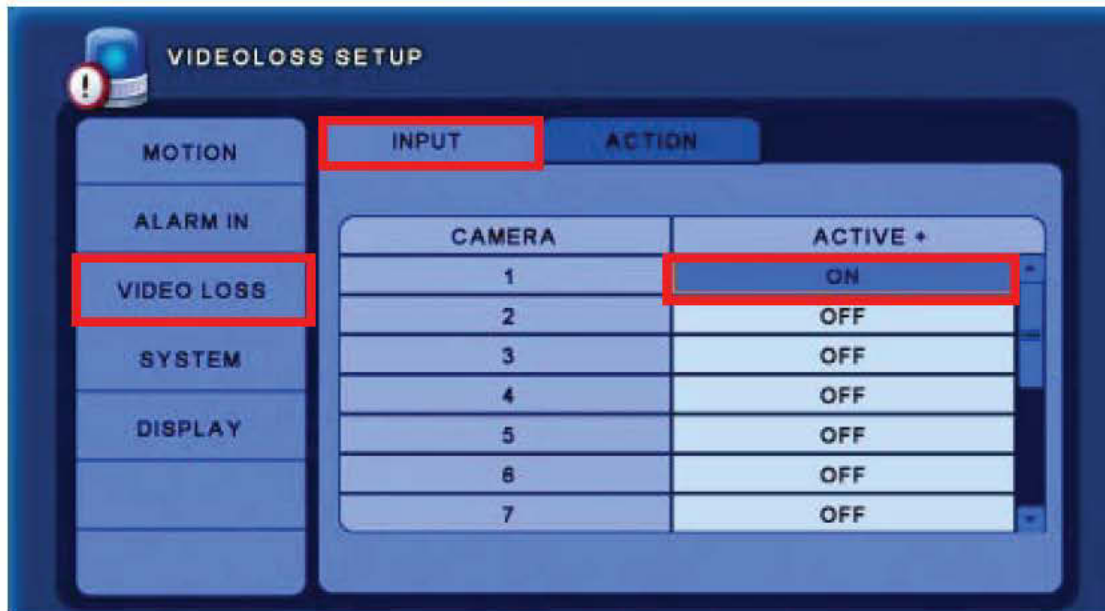

- **Active:** Setting video loss to [ON] will trigger the items selected within the "Action" tab.

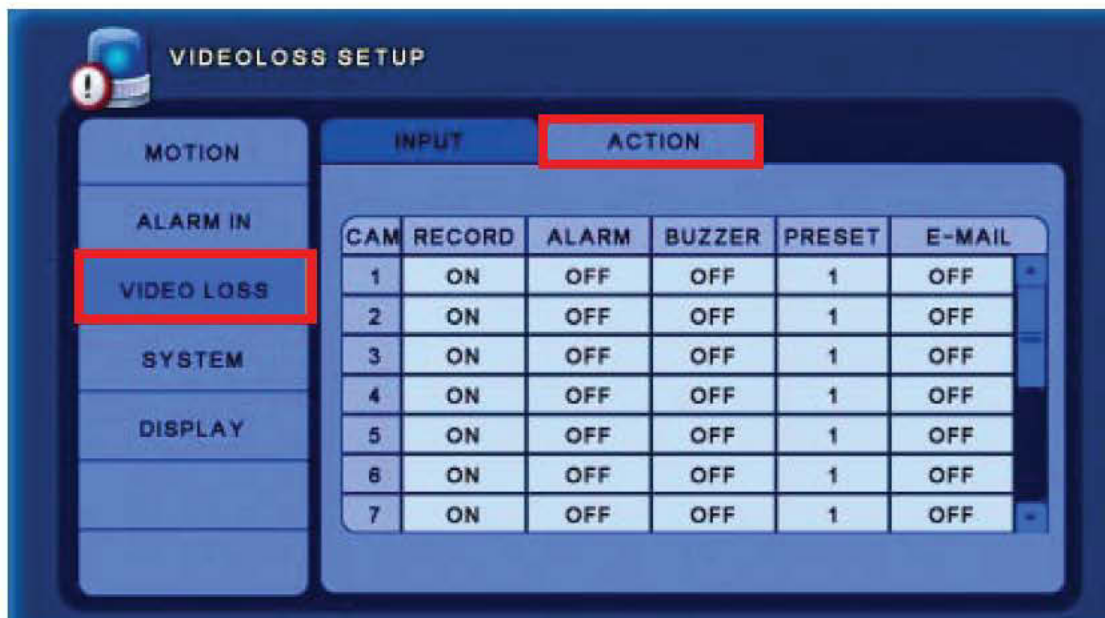

- **Record:** Select which channels to record when video loss occurs.
- **Alarm:** Select On to enable the selected alarm to trigger upon video loss of the associated channel.
- **Buzzer:** Select On to enable an audible chime from the DVR when video loss occurs.
- **Preset:** Set the preset number. (When video loss occurs, a PTZ camera will move to the preset position.)
- **Email:** Select On to receive an email notification when video loss occurs. Define email recipients in the following menu: Setup / Network / Email. See page 48 for details.

SETUP / Event / System

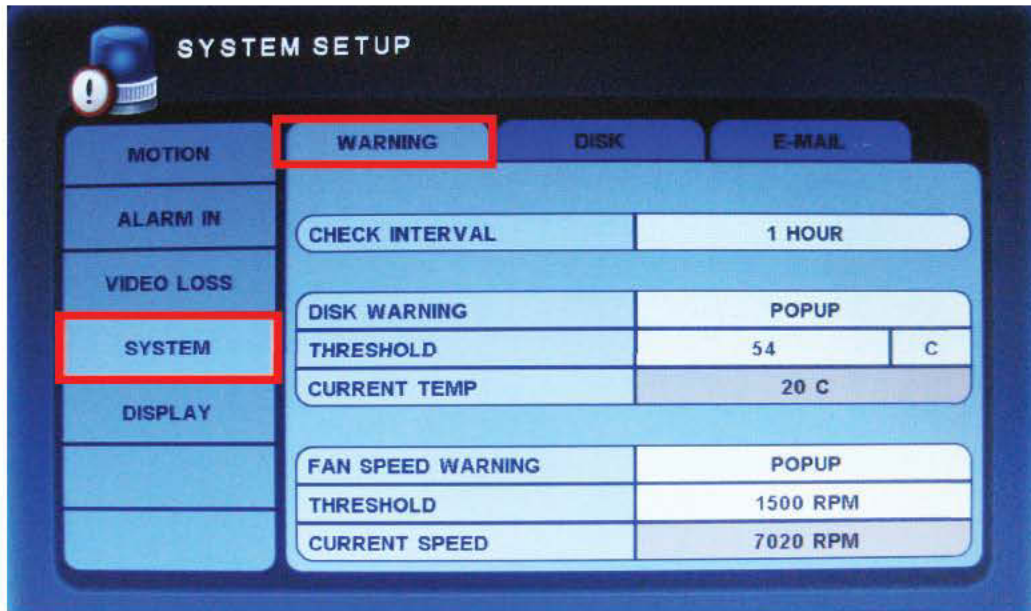

- **Check Interval:** Select the check interval time. This is how often the DVR will preform a smart check of the HDD.
- **Disk Warning:** Select to notify user of a smart check or over temperature warning.
- **Threshold:** Select the warning temperature threshold.
- **Fan Speed Warning:** Select to enable a warning when fan speed falls below the threshold.
NOTE: This option not available on Shadow Series.
- **Threshold:** Select the warning fan speed threshold. *NOTE: This option not available on Shadow Series.*

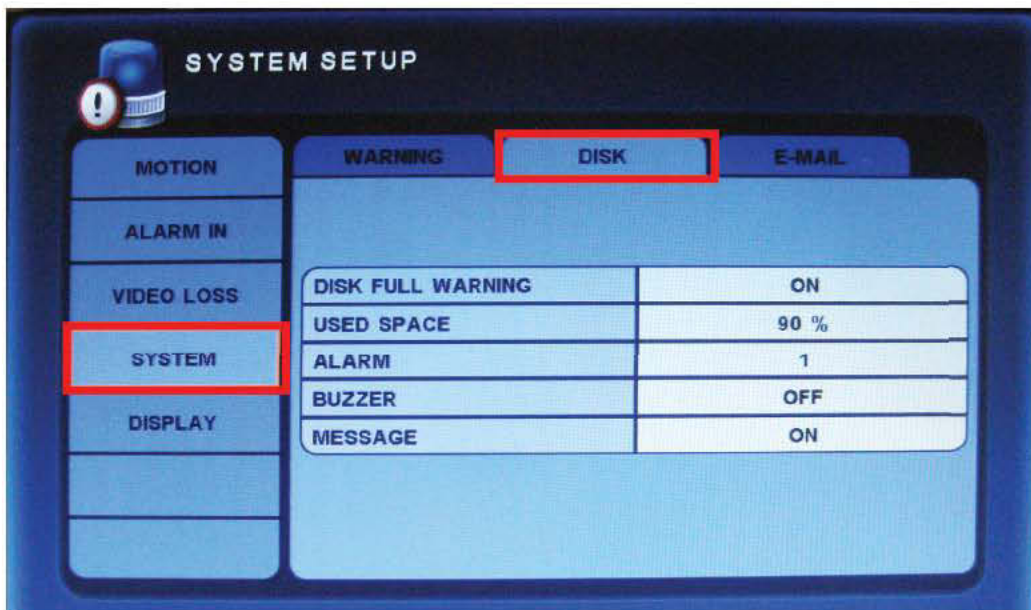

- **Disk Full Warning:** Select to notify user when the HDD reaches the used space limit.
NOTE: This is automatically disabled when HDD overwrite is enabled.
- **Used Space:** Select the HDD full percentage.
- **Alarm:** Select the channel for alarm out.
- **Buzzer:** Select On to enable the buzzer.
- **Message:** Select On to enable message.

SETUP / Event / System: Email & Display

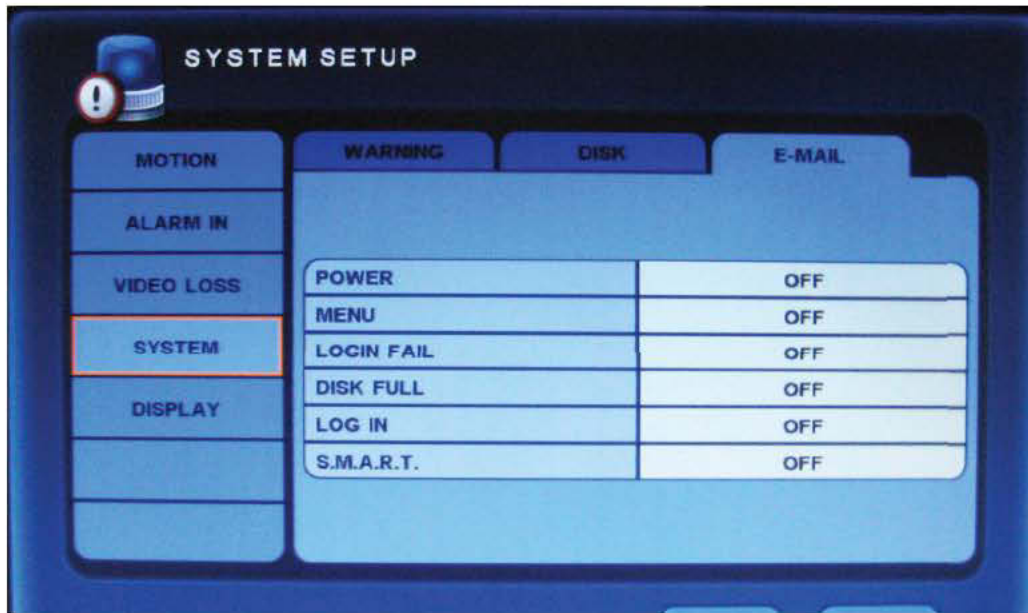

Select On to have an email sent to you when the following occur:
Power, Menu, Login Fail, Disk Full, Log In, S.M.A.R.T. (Smart monitors internal operations of the HDD and warns of potential problems.)

Note: Email can be set up in the Setup / Network / Email menu. See page 48 for details.

Configuring the Display will define the action taken by the DVR when an event occurs.

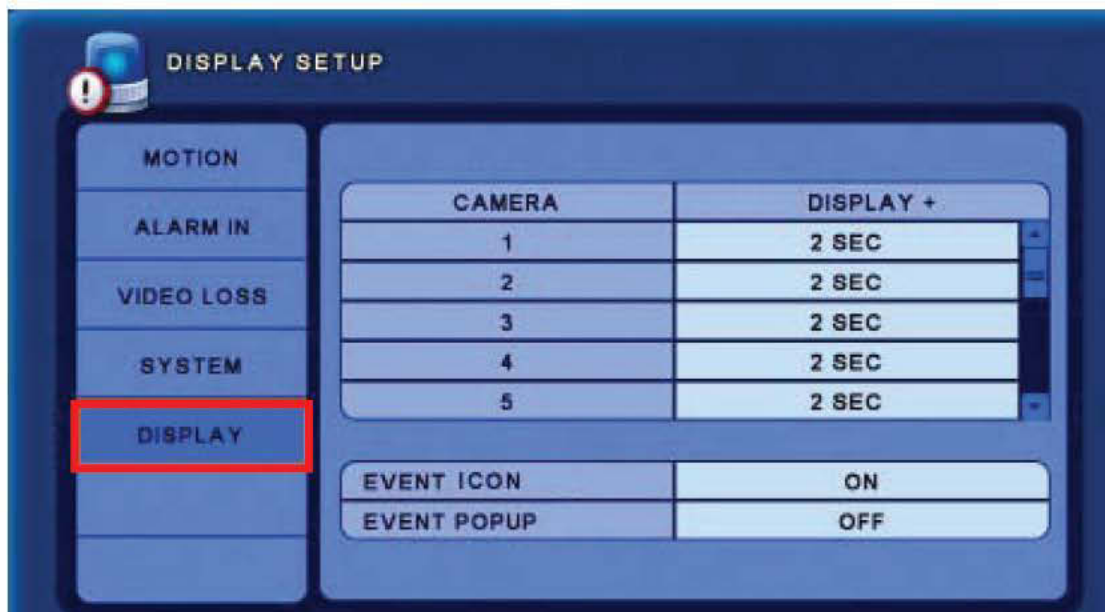

- **Display:** Select the duration you would like the Icon/Popup to display. (Select 0 to 100 seconds)
- **Event Icon:** Select On to display the event icon at the bottom of the screen when an event occurs.
- **Event Popup:** Select On to display the camera full screen when an event occurs.

SETUP / Record / Resolution

Within the Record Menu you can adjust settings for Resolution, Schedule, Record, Audio, and Manual.

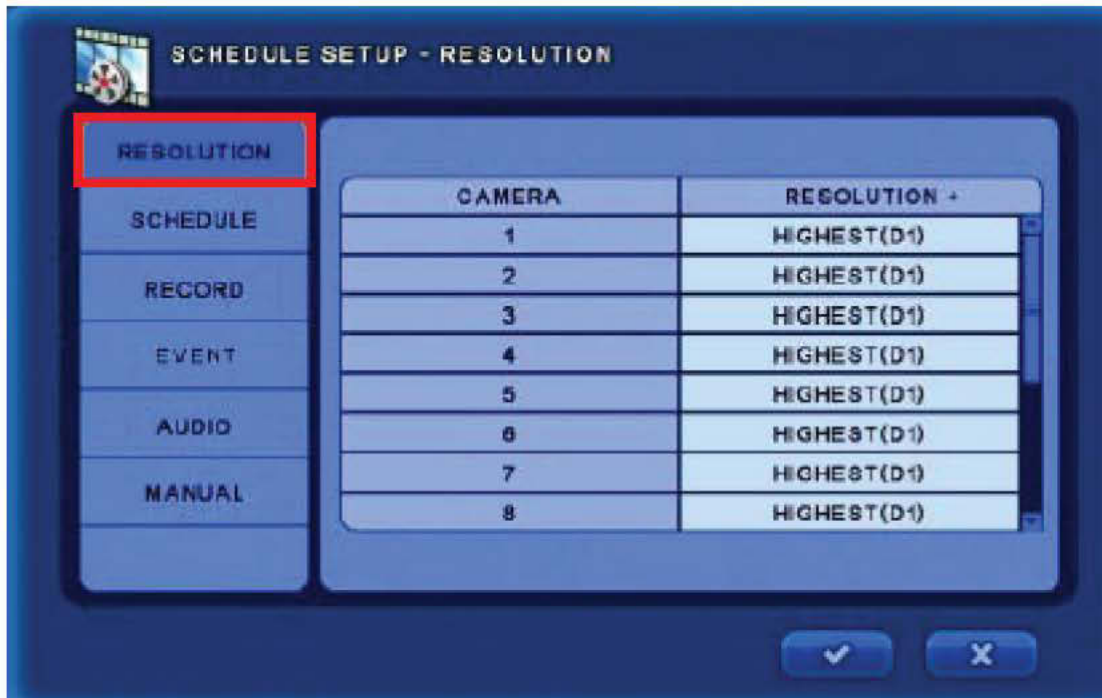

Schedule: Resolution

Factory settings will record motion at Half D1 (352x480) at 10 FPS.

- **Resolution:** Select the recording resolution for each channel.

STD (CIF) = 352x240

HIGH (Half D1) = 352x480

HIGHEST (D1) = 704x480

SETUP / Record / Schedule

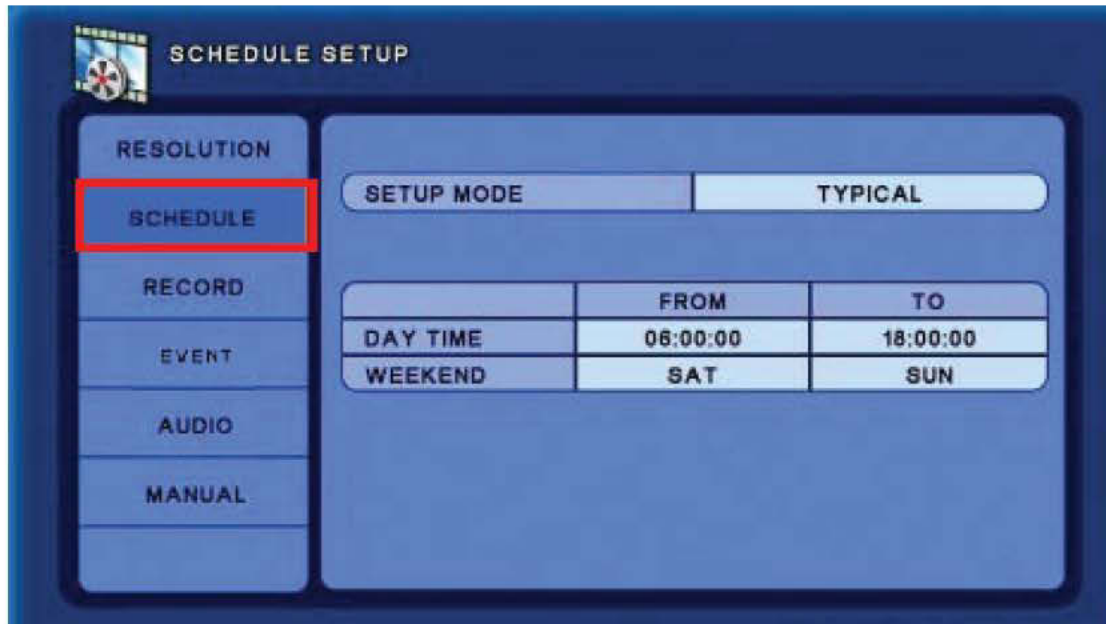

- **Setup Mode:** Select the record schedule. (Typical / Custom)

Typical:

- **Day Time:** Select the day time. (The night time is changed automatically according to the day time period that is set.)
- **Weekend:** Set the weekend zone.

Custom:

You can define up to three separate recording schedules based on a 24 hour day, days of the week, and holidays. This custom recording schedule will pull settings from the "Record" menu, so settings should match.

Cell Selection:

First select the desired recording schedule (REC1, REC2, REC3, or NONE). To select a block of cells, left click and drag the cursor to the desired block endpoint. To select a single cell only, left click on the cell.

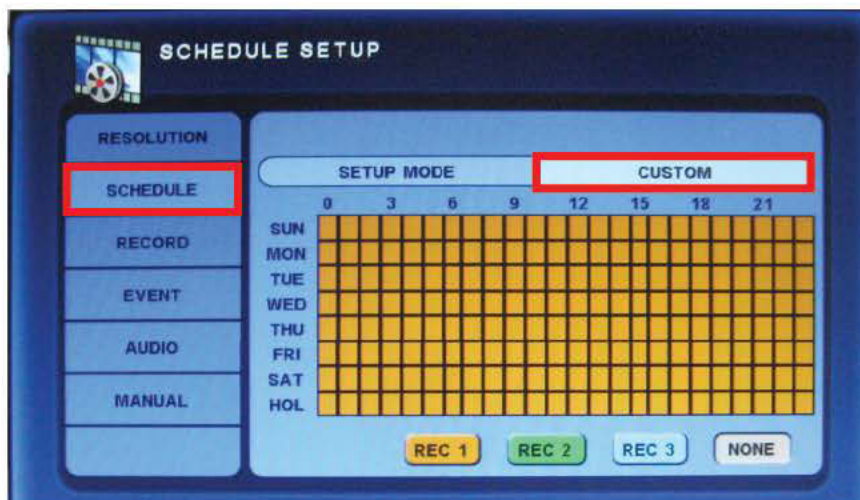

Custom Recording Schedule Screen

SETUP / Record / Record

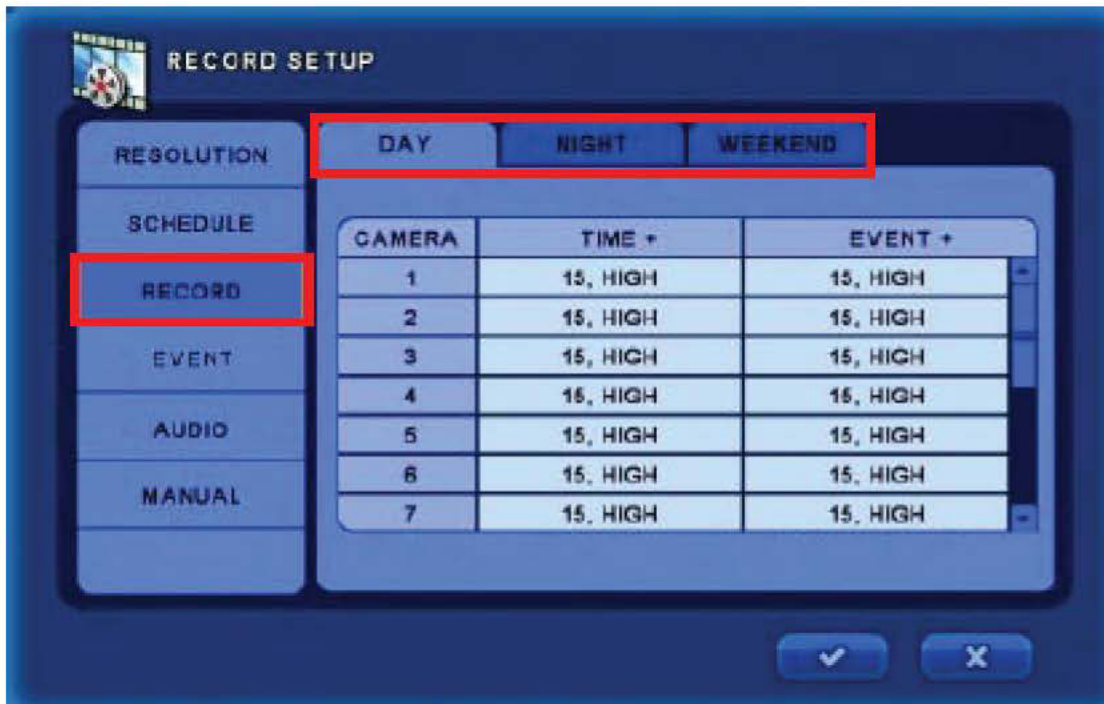

Record

Recording Quality levels will affect the compression level. (Lower quality will result in less Hard Drive space consumed.)

- **Time:** For time (continuous) recording select the recording frame rate and quality for each channel.
- **Event:** For event (motion) recording- select the recording frame rate and quality for each channel.

Notes:

If you wish to enable "EVENT" (motion) recording, you must set the "TIME" (continuous) recording frame rate to "OFF" for all desired periods (day, night, weekend).

If the setting for Schedule is switched from "Typical" to "Custom", you will see the Record page tabs as "REC1 / REC2 / REC3".

The default for Pre-recording is 5-seconds, and Post-recording is 3-seconds. To apply changes to these settings, select the "Event" tab.

Tip:

To change the FPS/quality of all cameras simultaneously in the selected period, make changes in the top-level menu by clicking on "TIME+" or "EVENT+".

SETUP / Record / Event & Audio

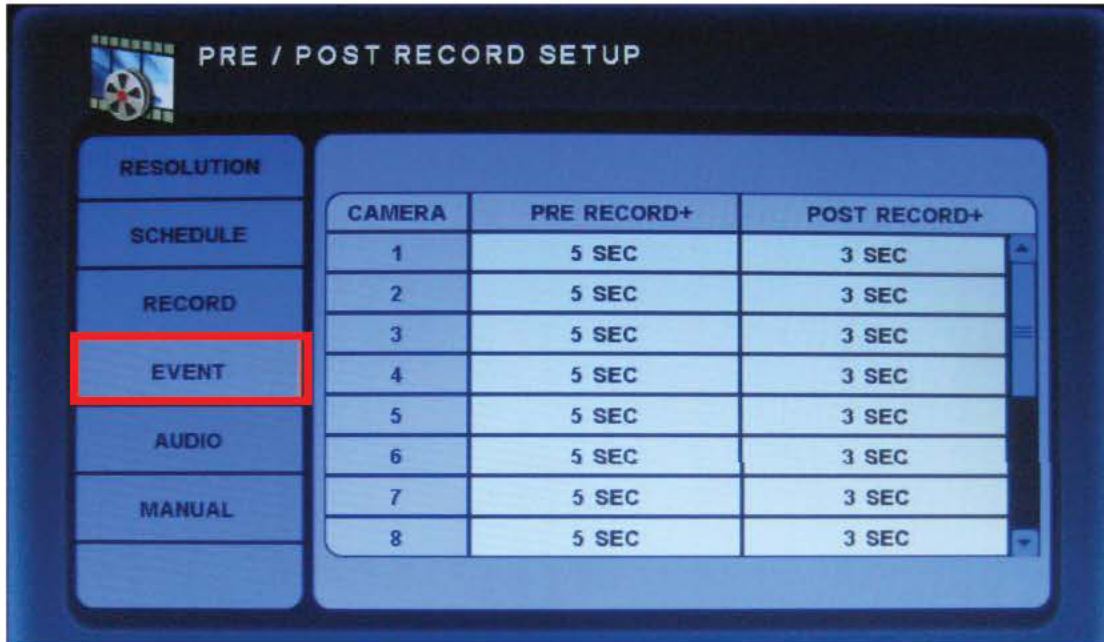

Event (Pre / Post Record Setup)

Here you can define the recording parameters before and after an event occurs.

- **Pre-Record:** Set the time that you wish to record before an event occurs. (The DVR will continuously store footage for the selected "Pre-Record" time, and then save that data when an event actually occurs.)
- **Post Record:** Set the time that you wish to record after an event occurs.

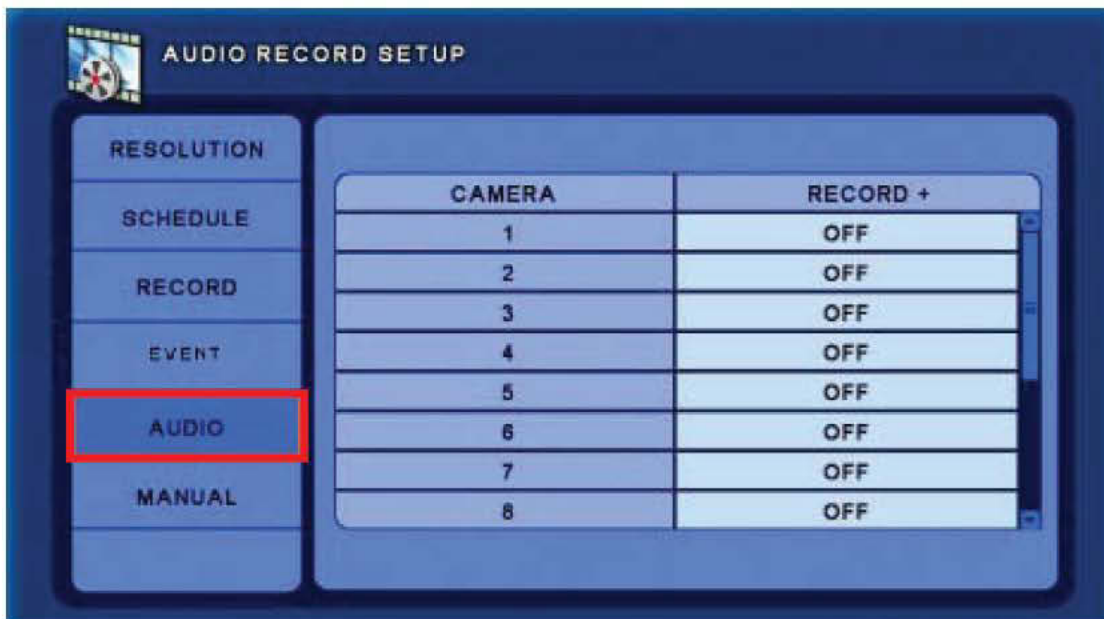

Audio Record

Here you can turn audio recording On / Off for each channel.

- **Record:** Select On to enable audio recording for the corresponding channel. Audio device must be connected to the back of the DVR.



Manual

Here you can define how the DVR will record when the manual record feature is selected with the Record button on the remote control.

- **Speed:** Select the recording frame rate for each channel.
- **Quality:** Select the quality for each channel.
- **Audio:** Select On to enable audio recording for each channel.

SETUP / Network / Network: Ethernet

Within the Network Menu you can configure the Serial, DDNS, and E-mail settings.

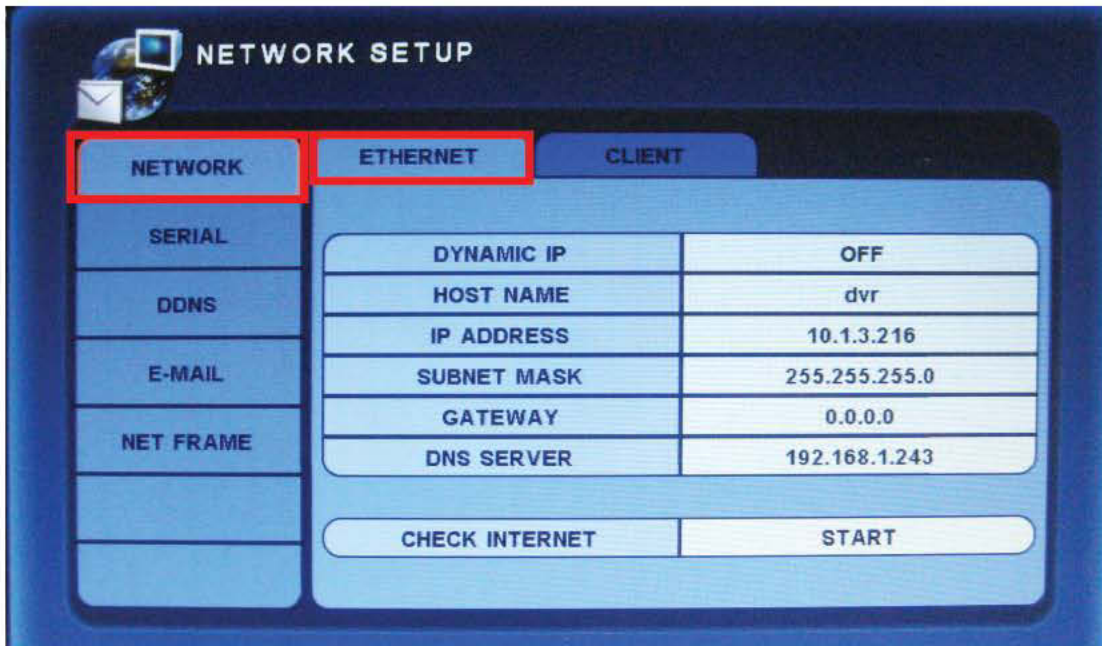

- **Dynamic IP:** Turn this setting ON to have the DVR automatically place your network settings into the corresponding fields. Click the ✓ save icon to apply the settings.

Tip:

When your "Check Internet" test is successful, turn Dynamic IP back off and click the ✓ save icon again in order to avoid the DVR grabbing an invalid IP address in the future. See Check Internet below for more information.

- **Host Name:** Input a desired host name.

For further info on these fields, see our support page at www.clintonelectronics.com.

- **IP Address:** Input an IP address for the DVR. (Dynamic IP must be off to edit this selection)
- **Subnet Mask:** Input the Subnet Mask here. (Dynamic IP must be off to edit this selection)
- **Gateway:** Input the Gateway Address here. (Dynamic IP must be off to edit this selection)
- **DNS Server:** Input the DNS Server Address here. (Dynamic IP must be off to edit this selection)

- **Check Internet:** Press "Start" next to Check Internet to check the internet status.
If Successful: "Internet access has succeeded"
If Unsuccessful: "Internet access has failed"

Note: You must have proper DNS server address for "Check Internet" test to be successful.

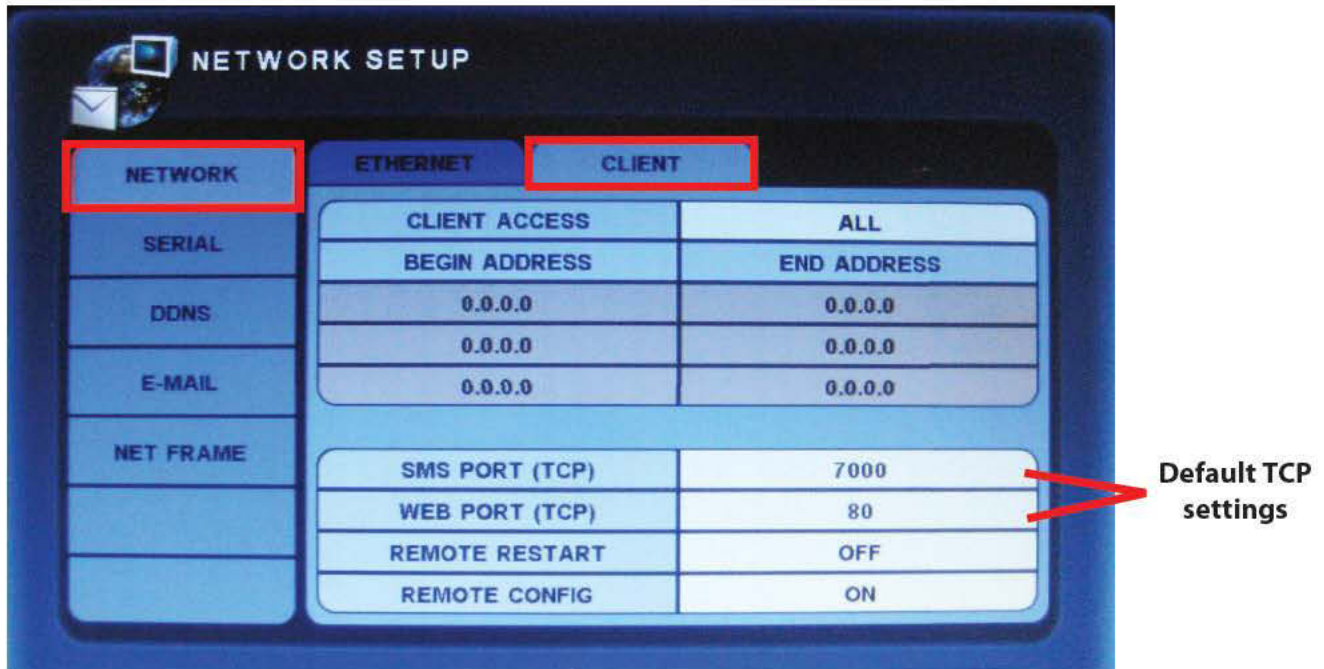

Client:

- **Client Access:** Select a range of IP addresses that can access the DVR. Select "ALL" to enable searching of all IP addresses.
- **Begin Address / End Address:** Enter the desired beginning and ending address for client access when range is selected above.
- **SMS Port (TCP):** Select the SMS port. (Default is 7000)
- **Web Port (TCP):** Select the Web port. (Default is 80)
- **Remote Restart:** Select ON to enable restarting of the DVR from a remote location via IP.
- **Remote Config:** Select ON to enable configuration of the DVR from a remote location via IP.

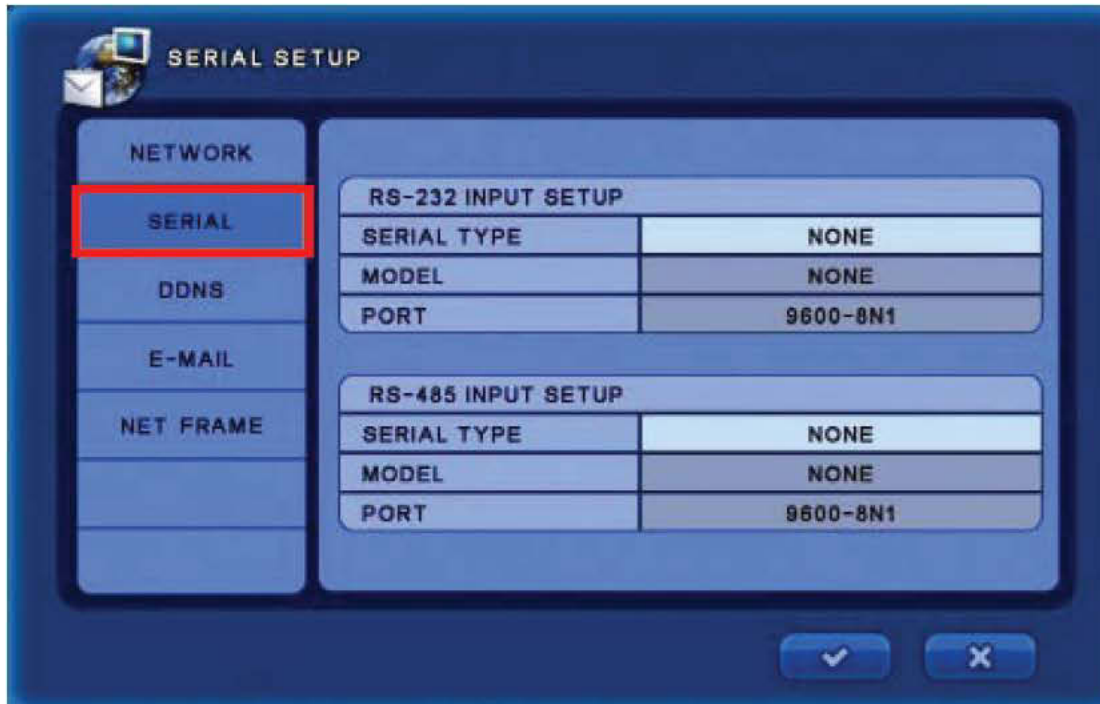

RS-232 Input Setup: *NOTE: The following options are not available on Shadow Series.*

- **Serial Type:** Select an external device..
- **Model:** Select the protocol to use.
- **Port:** Select the Baud Rate / DATA bit / Parity / Stop Bit.

RS-485 Input Setup:

- **Serial Type:** Select an external device..
- **Model:** Select the protocol to use.
- **Port:** Select the Baud Rate / DATA bit / Parity / Stop Bit.

SETUP / Network / DDNS

DDNS should only be set up if using a dynamic IP address. Check with your internet service provider to see if you are using a dynamic IP address.

DDNS SETUP

NETWORK	DDNS SERVER	NONE
SERIAL	HOST NAME	
DDNS	USER NAME	
E-MAIL	PASSWORD	****
NET FRAME	ROUTER IP	OFF
	STATUS	UNCHECKED
		CHECK

✓ X

- **DDNS Server:** Select DDNS server. (Ddnsdvr.com / Dyndns.com / ChangelP.com / etc.)
- **Host Name:** Input the host name registered on the DDNS server.
- **User Name:** Input the user name registered on the DDNS server.
- **Password:** Input the password registered on the DDNS server.
- **Router IP:** Select On to send IP information to the DDNS server. (This should be set to On when using a router)
- **Status:** Check the connection status.

NOTE: When using a DDNS server, first complete the host name, user name, and password registration on the DDNS server, and then input the information into the DVR. For information on setting up a free DDNS service, see the DDNS service setup guide included with the DVR, or download it online at www.clintonelectronics.com.

SETUP / Network / E-Mail

E-MAIL SETUP

ADDRESS

SEND E-MAIL	SCHEDULE	FROM	TO
ON	ON	00:00:00	23:59:59

NO.	E-MAIL ADDRESS
1	email@ddnsdvr.com
2	email@ddnsdvr.com
3	email@ddnsdvr.com
4	email@ddnsdvr.com
5	email@ddnsdvr.com
6	email@ddnsdvr.com

- **Send E-mail:** Select On to configure the email setup and to enable email sending.
- **Schedule:** Set to On to define time frame to receive emails. (From = Start time / To = End Time). If set to Off, the DVR will send emails 24 hours a day, 7 days a week.
- **E-mail Address:** Input the email address to receive.

E-MAIL SETUP

SERVER

MAIL SERVER	SMTP SERVER
USER NAME	UserName
USER E-MAIL	email@ddnsdvr.com
SERVER ADDRESS	ddnsdvr.com
SERVER PORT	25
LOGIN ID	UserId
LOGIN PASSWORD	****

- **Mail Server:** Select the mail server. (SMTP server / DVR System) If DVR system is selected, no server settings are required.
- **User Name:** Input the username.
- **User E-mail:** Input the user email address.
- **Server Address:** Input the server address.
- **Server Port:** Input the server port number.
- **Login ID:** Input the login ID.
- **Login Password:** Input the login password.

SETUP / Network / Net Frame

With Net Frame you can define the network limits for Frames per Second and quality for the live viewer. Setting to a lower quality and frames per second will result in less data transfer for lower bandwidth applications.

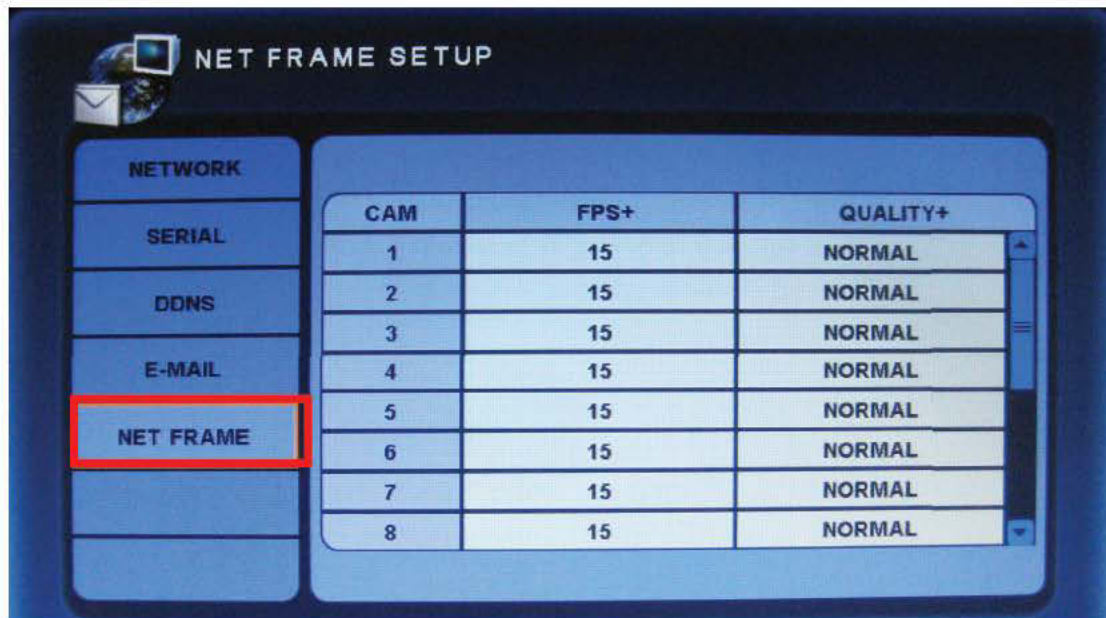

- **FPS:** Select the desired frames per second for live viewer.
- **Quality:** Select the desired quality level for live viewer.

SETUP / System / System Log

Within the System Menu you can view the System Log, and Version, as well as configure the Status.

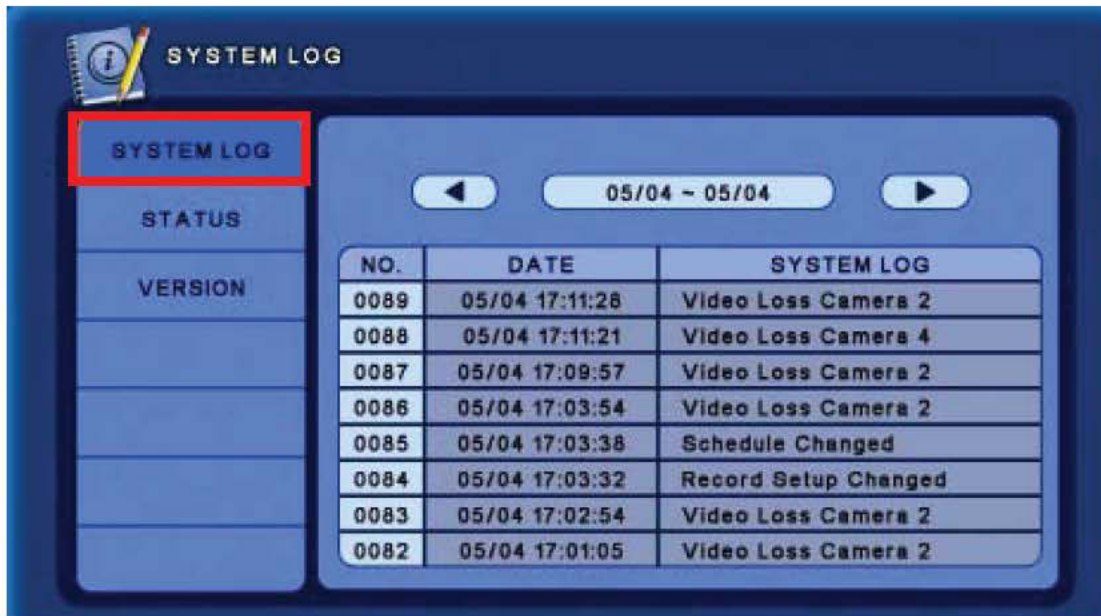

- **System Log:** Use this option to view the system log event list. Use the Left and Right arrows to browse through the system log. The event date range will be shown in the center of the two arrow buttons.

A quick link to this same information and menu can be found under the main menu when you move the cursor to the top of the screen.



SETUP / System / Status

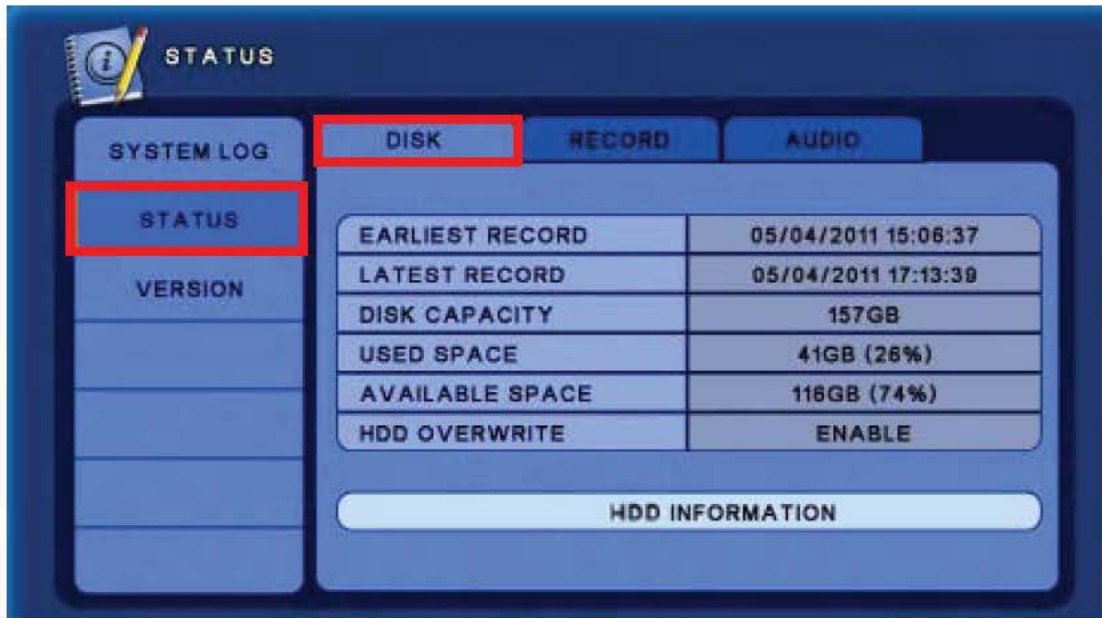

Disk: Display the Hard Drive status

- **HDD Information:** Show the Hard Drive information.



Record: Display the current recording status.

SETUP / System / Status:Audio & Version

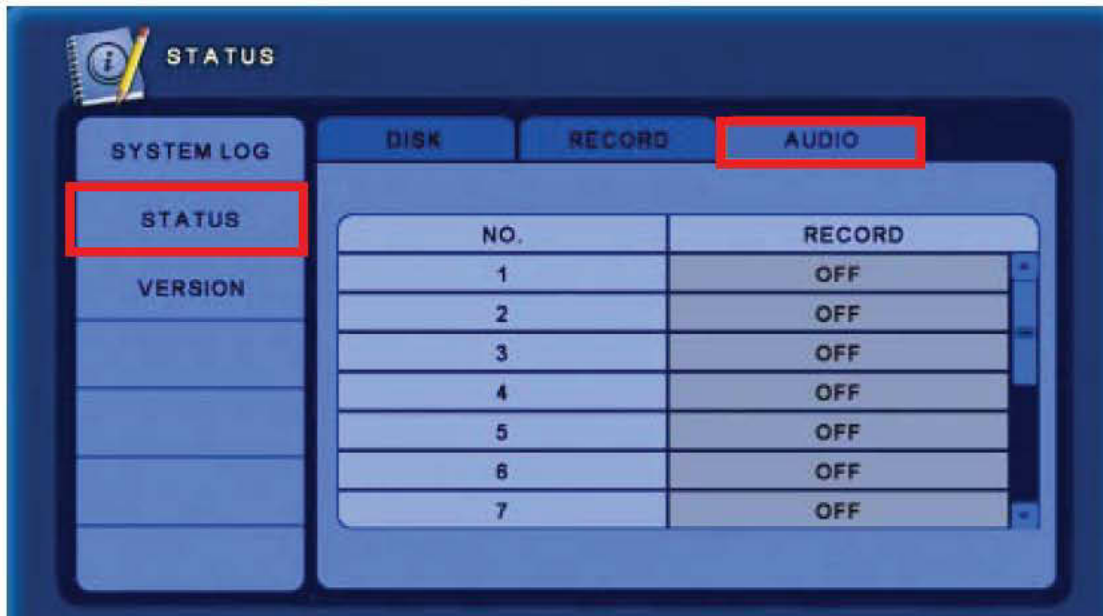

Audio: Display the Audio status

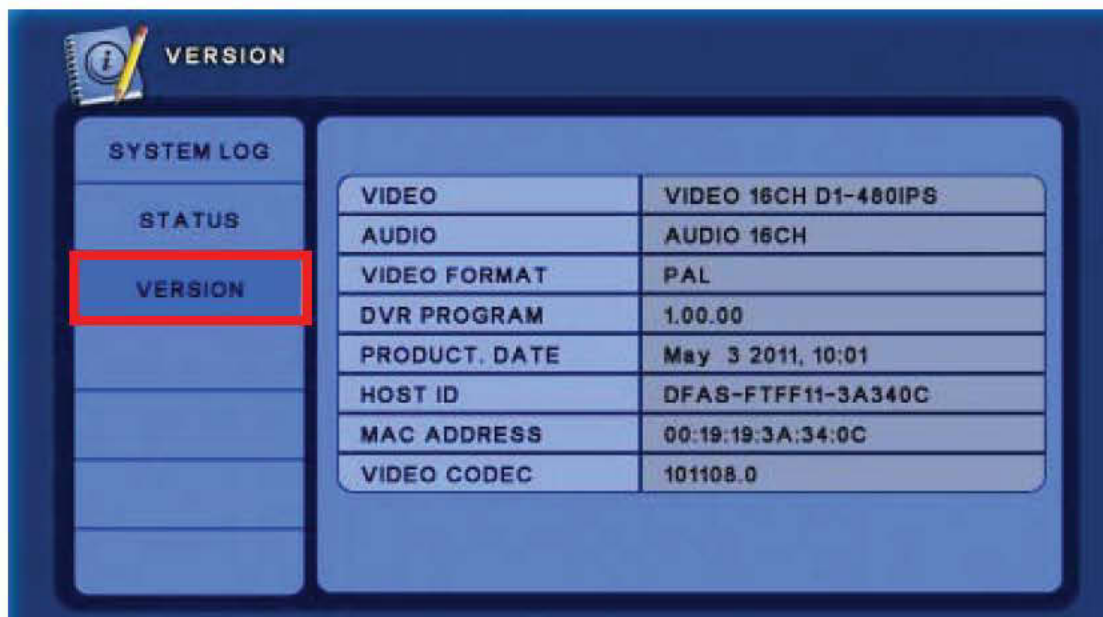

Version: Display the DVR version and information

SEARCH

Within the Search Menu you can search through recorded content by various methods.

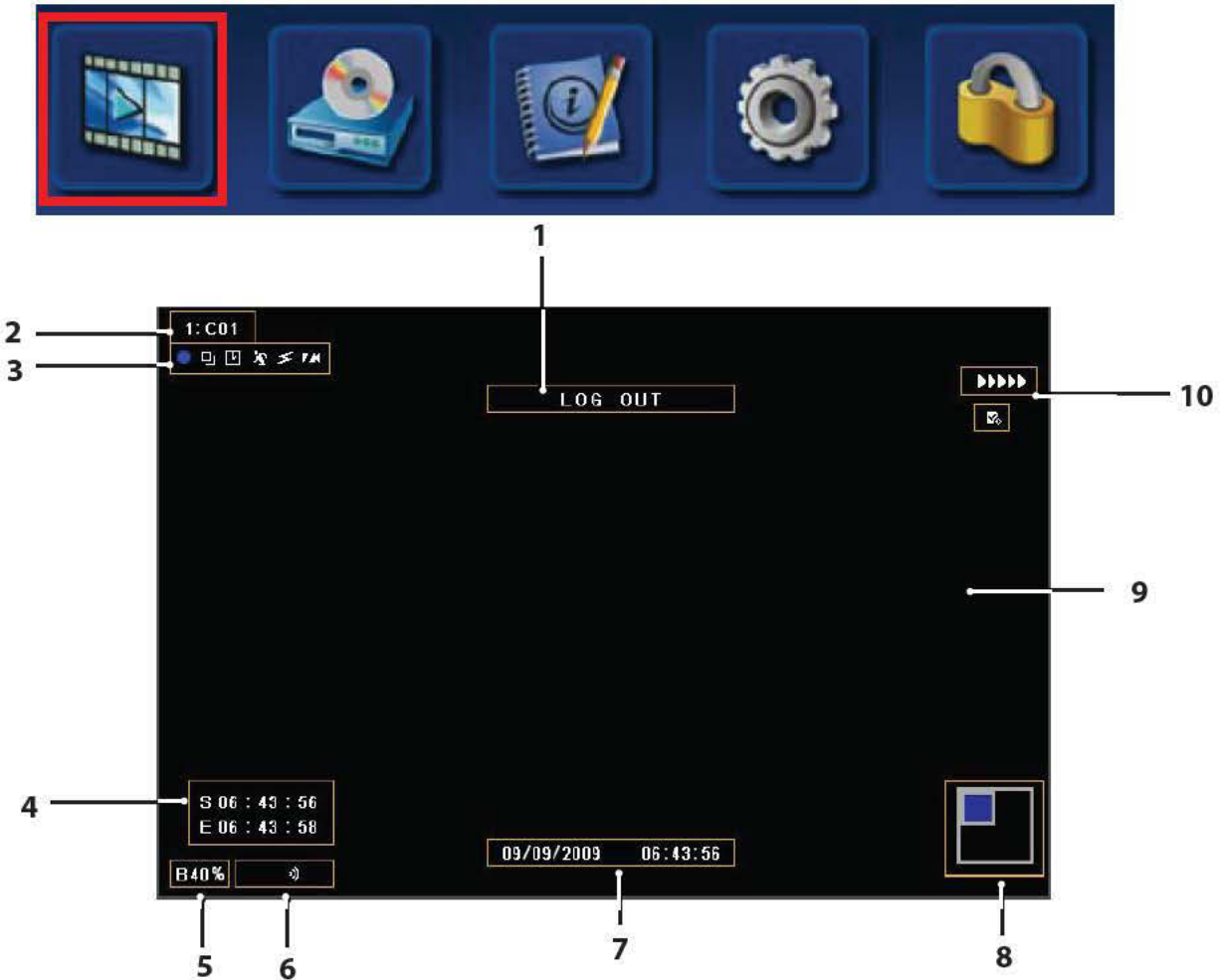

SCREEN AREA LEGEND

1. Execution Information Message
2. Camera Name
3. Search Status Icon-
 - **Search Icon** (Blue): Shows when search mode is active within the live screen.
 - **Sequence Icon**: Shows when screen sequencing is active.
 - **Time Icon**: Shows when time (schedule) record mode is active.
 - 👤 **Motion Icon**: Shows when motion occurs.
 - 📡 **Sensor Icon**: Shows when the external sensor is triggered.
 - 📺 **Video-Loss Icon**: Shows when no video input is sensed.
4. Repeat Segment: Start time, End time
5. Backup Progress Status %
6. Current Channel Information Icon-
 - 🔊 **Audio Icon**: Shows when audio occurs within the recording.
7. Date and Time of Recording
8. Zoom 2x / 4x Location
9. Search Screen
10. Search Information Icon

SEARCH

When using the search features listed below, move the mouse cursor to the bottom of the screen to bring up the control panel. Control panel functions can alternatively be selected by using the corresponding buttons on the remote control.

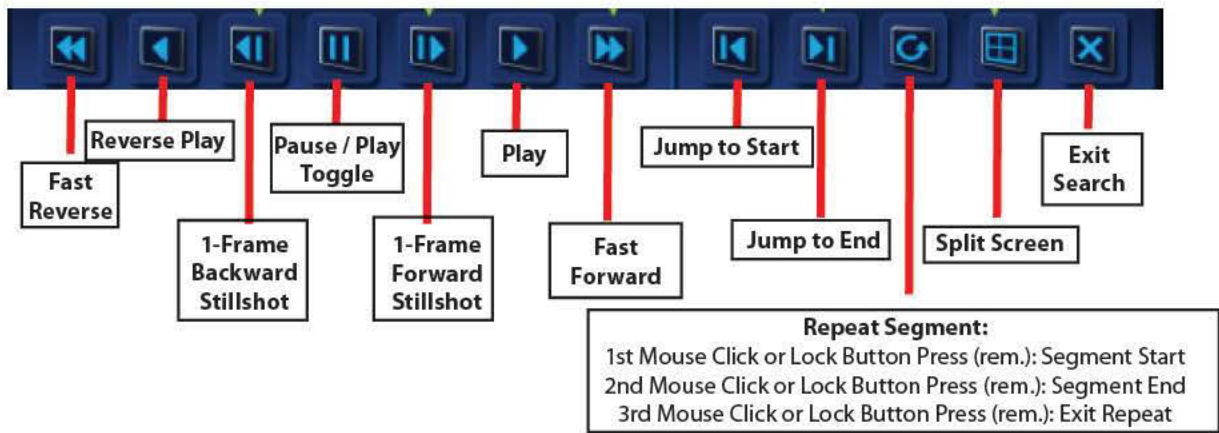

- **Target:** Select the drive in which you wish to view content. (Search capability may be limited with certain drives.)
- **Quick Search:** Quickly search through recorded footage by entering the exact date and time.
- **Calendar:** Narrow your search by selecting date and time.
- **Event Search:** Search for events by camera number, date & time, and event type in the event log.
- **Overlapped List:** Search for overlapped data that occurs from removing DST or from changing the time backwards.
- **Go to First:** Jump to the first data saved on the selected drive.
- **Go to Last:** Jump to the last data saved on the selected drive.

NO	DEVICE	MODEL	SPACE
1	HDD	ST31000524A	986GB
2	DVD-RW	HL-DT-ST	

Target Selection screen

YEAR	MONTH	DAY	HOUR	MIN
2012	3	14	7	40

Quick Search Screen

SEARCH / Calendar

For best results use calendar search function.

- **Calendar:** Narrow your search by selecting date and time.
 1. Select a highlighted calendar day.
 2. Select the hour you wish to begin viewing footage.
 3. Select the minute you wish to begin viewing footage.

Color Indication:

A highlighted day indicates recorded content

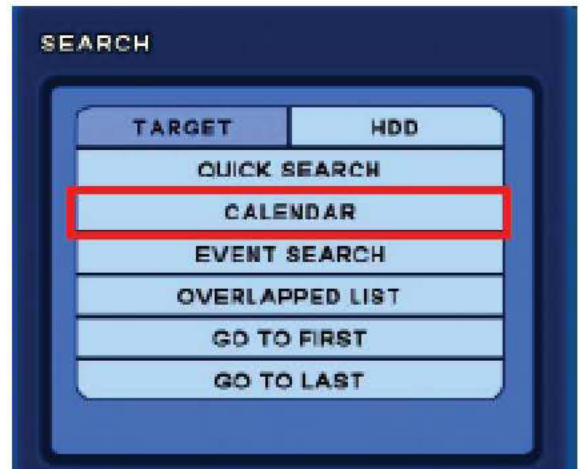

Click in the content window, or move the arrow indicator to select the desired time frame. Click the ✓ icon to proceed.

Color Indications:

- Blue: Continuous Recording
- Teal: Audio Recording
- Red: Event recording

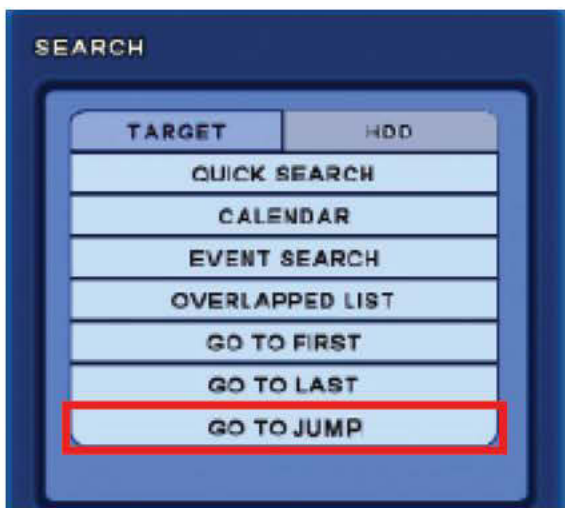
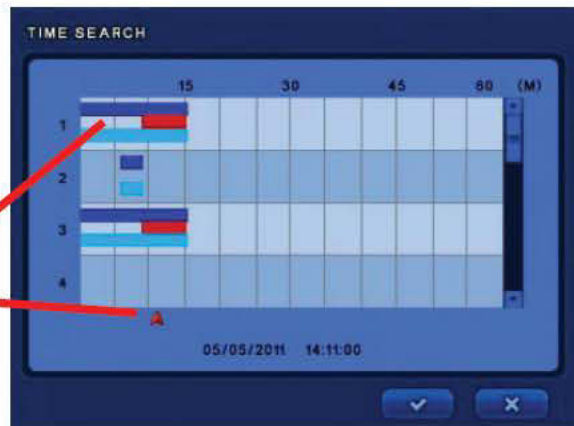

During playback select the search icon in the top menu, and select "Go to Jump" to quickly change the playback time as much as 12 hours at a time.

SEARCH / Event



• **Event Search:** Search for events by camera number, date & time, and event type in the event log. DVR must be recording by motion, alarm-in, or video loss in order to generate an event list.



- **Date:** Select the date to search.
- **Motion:** Select On to search for motion events.
- **Alarm In:** Select On to search for an alarm activated event.
- **Video Loss:** Select On to search for a video loss event.
- **Select Camera:** Narrow your search by selecting a specific camera or multiple cameras.
- **View Search Log:** View the results from the specified criteria above.

NOTE: One of the preceding must be set to ON in order to view the results. (Motion, Alarm In, Video Loss). If at least one of these is not selected you will not be able to view the search log.



- **No:** Select the event segment you wish to playback.
- **Hour:** Select the time range to view.
- **Prev:** Display previous search results page.
- **Next:** Display next search results page.
- **GoTo:** Input an event page start number.

NOTE: Use the scroll wheel on the mouse or the fast forward button on the remote control to cycle through the search result log. If a list is blank then no events for the specified search have been found.

SEARCH / Overlapped List

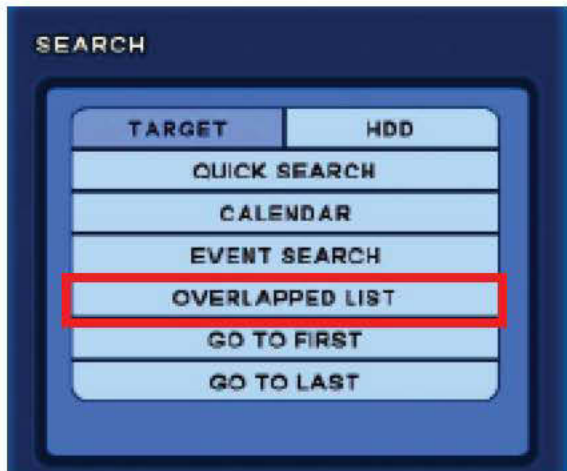

• **Overlapped List:** Search for overlapped data that occurs from removing DST (daylight savings time) or from changing the time backwards on the DVR.

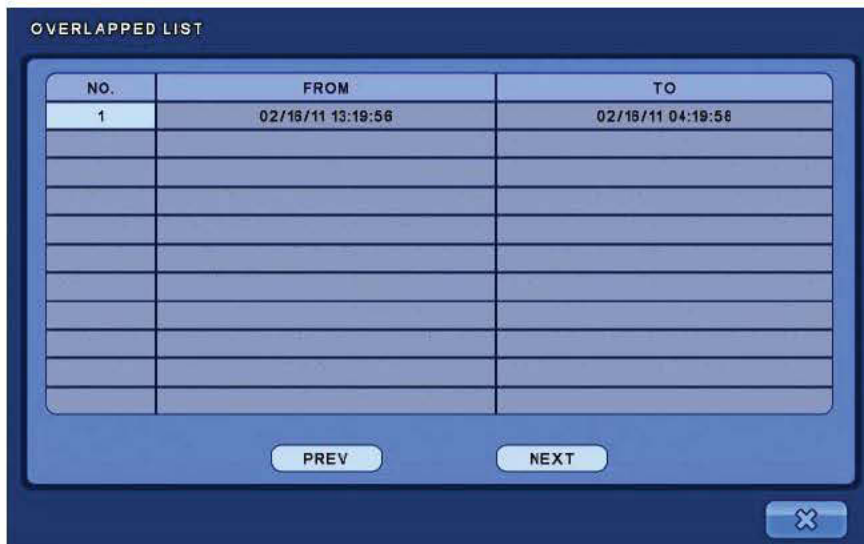

Select the Overlapped list number you wish to view. (see image left)



You can then select the method in which to search the data. (Quick Search, or Event Search) (see image above)

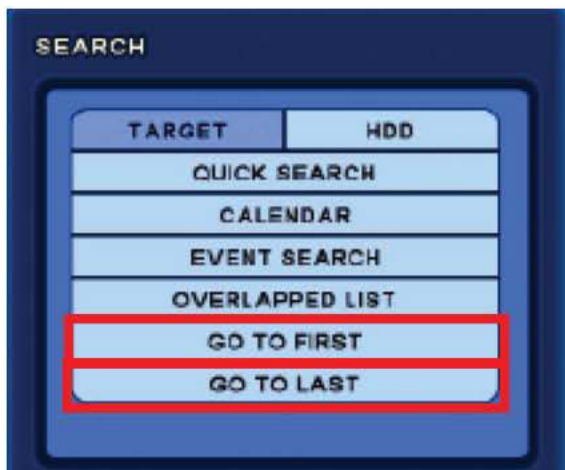

• **Go to First:** Jump to the first data saved on the drive that is selected in "Target".

• **Go to Last:** Jump to the last data saved on the drive that is selected in "Target".

SEARCH / Panorama & Smart Search

Panorama Search: Display up to 16 consecutive still frames for a selected playback segment. This enables you to more accurately pinpoint the specific moment that an event may occur.

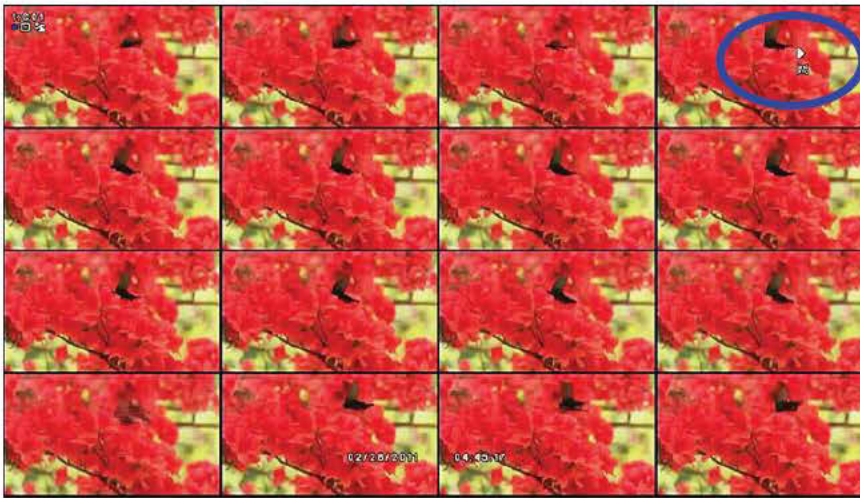

- **Panorama Mode:** Enables Panorama Search- right-click on a camera during playback and select "Panorama", then click "Panorama Mode" to initiate.

- **Mode Change:** Changes the number of panorama frames shown per screen. Toggles from 4-up, 9-up, 16-up. Similarly, you can change this by clicking the "Split Screen" selection in the bottom menu.

- **Cancel Panorama:** Ends panorama search and returns to standard playback mode.

Smart Search: Narrow down your search further by using this feature to playback only instances of motion. This differs from motion search in that it will continuously play through all instances of motion as noted in the Event Search list.



BACKUP

Within the Backup Menu you can back-up recorded footage to an external device.

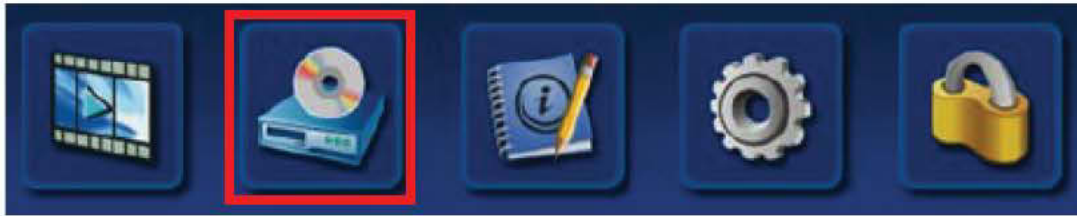

MANUAL BACKUP

TARGET	NONE	NONE
FROM	05/05/2011	13:30:05
TO	05/05/2011	14:17:33
BACKUP TITLE	backup	
SELECT CAMERA	ON	
EARLIEST RECORD	05/05/2011 13:30:05	
LATEST RECORD	05/05/2011 14:17:33	
REQUIRE SPACE	ESTIMATE	0.00MB

WRITE

X

Backup:

- **Target:** Select the backup destination device. (USB / DVD)
- **From:** Select the start date and time.
- **To:** Select the end date and time.
- **Backup Title:** Input a title for your backup file.
- **Select Camera:** Select the desired camera(s) for backup.
- **Earliest Record:** Shows the earliest content that has been recorded.
- **Latest Record:** Shows the latest content that has been recorded.
- **Require Space:** Select "Estimate" to show the data capacity for the selected data.

Note:

Estimate must be selected before the backup selection will be written to the media.

- **Write:** Start the backup.

BACKUP - SMS



Your DVR is packaged with a DVR Player program so you can view footage on your personal computer.

DVR Player is a program that is used for playing video files saved from the DVR on a PC. When backing up using a USB or DVR/CD at the DVR end, the DVR Player is saved with the data.

To play saved video on a PC, open the USB or DVD/CD drive and double click on DVR Player.

Click the + next to My PC.

Click the + next to the USB or DVD/CD drive.

Click the + next to the date folder.

Drag individual camera files to the appropriate screen.

Use control buttons at the bottom of the player window to playback video.

UPGRADE

Latest DVR firmware can be found online at www.ClintonElectronics.com/support.html. Follow the procedure below to install the firmware onto your DVR. To determine what firmware version your DVR currently has installed, see the Version screen under the Status menu. See page 52 for details.



Copy the firmware to a USB drive. The USB drive should be clear of any other data in order to avoid interference. It should also be formatted to FAT32 for best results.

Insert the USB drive into the top USB slot on the front of the DVR.

To update the firmware, restart the DVR as shown on page 27.



After restarting, the DVR Upgrade screen will appear. Select "Start".

NOTE: You must use the remote control on this screen. Mouse control not available.



After the upgrade has completed, remove the USB drive and select OK. The DVR will then be restarted.

NOTE: If you select OK before removing the USB drive, the DVR will initiate the firmware update again.



After restarting, the Upgrade Completed screen will appear. You can close this screen, the update has been applied.

Web Viewer Connect

Configure DVR

On the DVR, go to:
Setup --> Network --> Network --> Ethernet

Set dynamic IP to "ON".

Click the ✓ icon.

A popup will show "Are you sure you want to set new network?"

Click ✓ icon again

Go to Setup --> Network --> Network --> Ethernet

The DVR should show a new IP address

Turn Dynamic IP off to prevent the IP address from changing

Click ✓ icon again

A popup will show "Are you sure you want to set new network?"

Click ✓ icon again

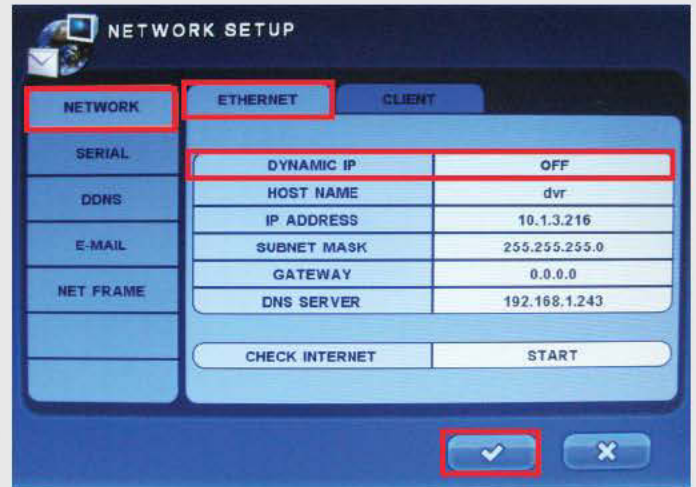

Configure Web Browser

On your computer, open Internet Explorer and go to:
Tools --> Internet Options --> Security --> Custom Level

Scroll down to "Download unsigned ActiveX controls"
Select "Prompt" and "OK" to save the settings.

Connect to DVR

In the address bar input the IP address that you set for your DVR.

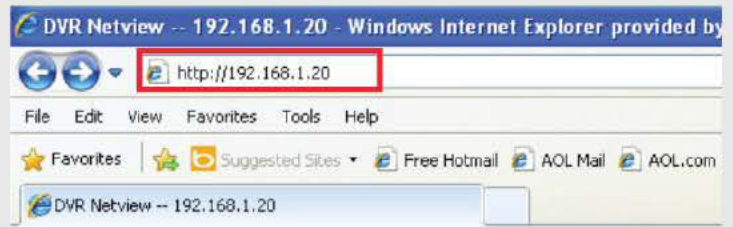

If you have changed the port number from the default of 80, then add the new port number in the address as well:

For example:
IP address: `http://192.168.1.20:81`

Install Controls

When the ActiveX dialog box appears, click "Install".



Login

Input the ID and password into the Login box. The defaults are as follows:

Default ID: remote
Default password: 1111



Click "Connect"

Web Viewer Functions

Web Viewer v2.5
11:29:06

Division Screen

1
2
3
4

Connect **Disconnect**

1. Control

Brightness

Contrast

2. PTZ

Zoom In

Zoom Out

3. Alarm

Alarm Out:
On/Off toggle

4. Search

Open Search

Exit Search

Mobile App

This section describes how you can setup and operate mobile apps for Clinton Electronics DVRs.

On your Android device (from the Google Play Store)



1. If you don't already have a Google Play Store account, you will need to create one on the play.google.com website before you can download any apps.
2. From your Android device, click on the Google Play Store button and navigate to the "CEC-Connect" app. You can do this by searching for the app name or searching for Clinton Electronics.
3. To install the app, tap to select it - the details screen will appear, and you can read more about the app, its features and the developer.
4. Tap the Download button to install the app.
5. Tap Accept & Download to accept the permissions for the app - your item will start downloading immediately.
6. To use the CEC-Connect app. Tap on the icon on your device to open the app.



On your Apple device (from the App Store)



1. If you don't already have an Apple App Store account, you can create one by downloading Apple iTunes on your computer by visiting apple.com/itunes, and then creating an account.
2. From your iPhone, iPod Touch, or iPad, click on the App store button and search for the "CEC Connect" app.
3. Select the app, and tap the "free" button, it will then change from "free" to "install". Tap again to install. Here is where you will enter your user name and password.
4. Once your device has started downloading the app, a status bar will show up to indicate how long it will take to download. Once it is complete, you can tap on the CEC-Connect icon to access the app.



Mobile App

Add DVR:

Tap the + button to enter the Add screen.



Tap in each text field to pull up the virtual keyboard. Input the desired connection name, IP-address, Port Number, and User ID and Password.



Access DVR:

Tap on the connection name to access the DVR.

To view the connection settings, tap on the arrow button.



Help Screen:

Tap on the ? button to pull up the help screen. This screen will show you touchscreen controls as well as define the bottom menu icons.

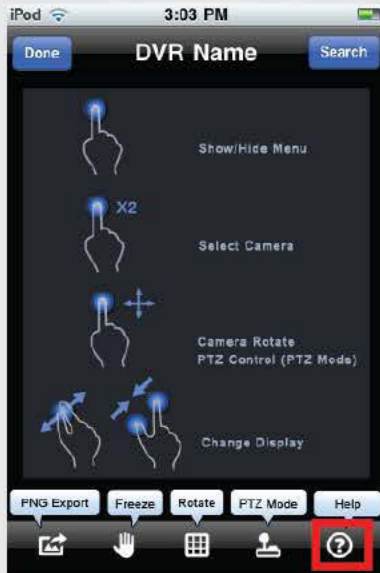

PNG Export: Saves a screenshot to your photo library on your mobile device.

Freeze: Pauses the current screen.

Rotate: Cycles through multiple cameras per screen (16-up, 8-up, 2-up when held vertically) (16-up, 9-up, 4-up when held horizontally).

PTZ Mode: Controls are only available in single-screen mode when viewing a PTZ-connected camera. Tap on one of the arrows (Up, Down, Left, Right) to pan or tilt the PTZ. Zoom feature is not available in the mobile app. Immediate response from the PTZ should not be expected when using the mobile app due to wifi or cellular connectivity.

Help: Displays a list of available touchscreen controls as well as defines the bottom-menu icons.

Live View:

If currently in Search screen, tap the LIVE button at the top to pull up live view.

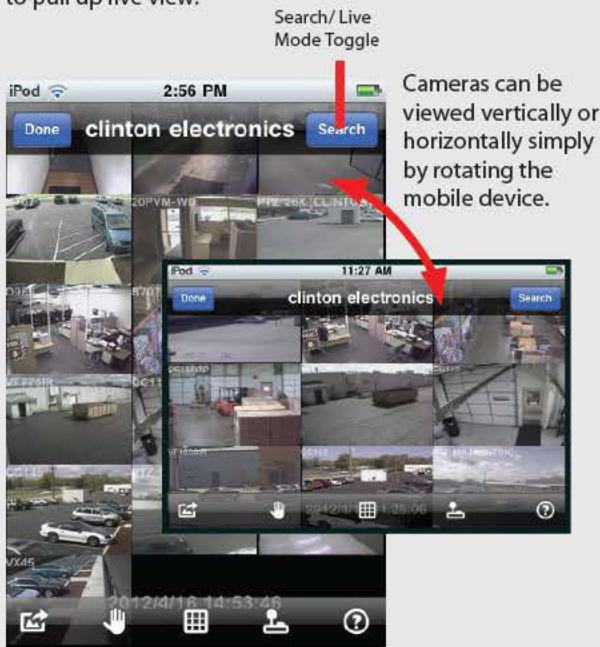

Search Screen:

If currently in Live screen, tap the SEARCH button at the top to pull up the search screen. Typical search button controls are located at the bottom: (skip back, reverse search, pause, play, fast forward search).

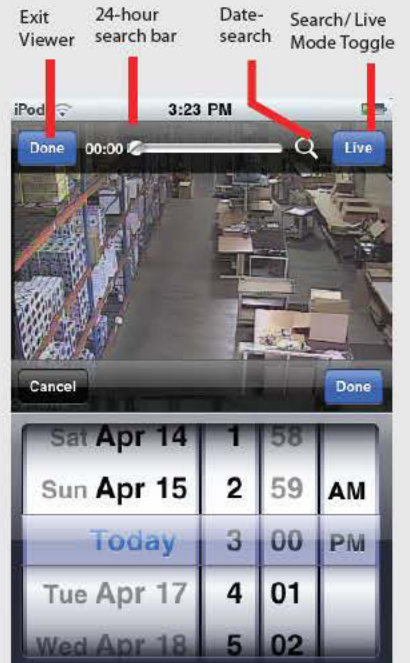

Specs - Shadow Series

SHADOW SERIES		CE-R4S	CE-R8S	CE-R16S
DISPLAY				
Video	Channels	4 Composite Video BNC Inputs	8 Composite Video BNC Inputs	16 Composite Video BNC Inputs
Live	Frame Rate	120 FPS	240 FPS	480 FPS
	Multi Screen Display	1 / 4	1 / 4 / 7 / 9	1 / 4 / 7 / 9 / 10 / 13 / 16
PERFORMANCE				
Operating System	Embedded	Linux		
	Compression	H.264 Enhanced Compression Method		
	Performance	Pentaplex		
Record Rate	CIF (352 x 240)	120 FPS	240 FPS	480 FPS
	1/2 D1 (704 x 240)	120 FPS	240 FPS	
	D1 (704 x 480)	120 FPS		
Recording	Mode	Schedule / Continuous / Event (Motion, Alarm)		
	Overwrite Mode	Continuous		
	Pre-alarm	Up to 60 seconds of Record Time		
	Post-alarm	Up to 100 seconds of Record Time		
Search & Playback	Search Mode	Date/Time, Event, Panorama (Frame by Frame), Smart Search		
	Playback Function	Fast forward/backward, Slow forward/backward, Step forward/backward		
Motion	Area	Adjustable Grid (22 x 15)		
	Sensitivity	5 Level Motion Detection		
System	Hidden Video Mode	Video is hidden from view while recording is still taking place		
	Private Zone	Black out an area in live and recorded view		
	Auto Time Sync	NTP (Network Time Protocol)		
	Firmware Update	Via USB or Auto firmware upgrade via Network Connection		
Event	SMART Alarm	Auto Detect and Monitor HDD problems.		
	Source	Motion / Alarm In / Video Loss		
Network	Action	Record, E-mail Notification, Log File, Send message to Remote, Buzzer, Pop Up Window, Alarm, PTZ Preset		
	Transmission Speed	CIF 120/100 FPS (Max.)		
	Bandwidth	8 Mbps - 50kbps, SMS 1Mbps min.		
	Bandwidth Control	Selectable		
	Stream	H.264 (CIF)		
	Max. Remote Users	Search & Live = 10 Users (Max.)		
	Protocol Support	Static IP, DHCP, DDNS		
	Monitoring	SMS Software, Web Viewer (Windows Internet Explorer, Mac OS X Safari), Smart Phone (Android, iPhone iOS)		
Smart Phone	Remote E-mail Notification	Motion, Video Loss, Power, Menu, Login Fail, Disk Full, Login, SMART, Alarm In		
	Smart Phone	Google Android (Not compatible with all Android phones), Apple iPhone iOS		
Storage	Max. Remote Users	1 User		
	Internal HDD (Standard)	1 TB Standard HDD		
	Optional HDDs	2 TB Optional HDD	2 TB or 3 TB Optional HDD	
	USB (Back Up)	1 USB Port, PC via SMS Remote Software		
Security	File Format	Proprietary DVR Format		
	Password Protection	2 Admin, 6 User		
	Data Authentication	Proprietary Data File		
INTERFACE				
Monitors	HDMI	1 HDMI (1920 x 1080p, 1920 x 1080i, 1440 x 900, 1280 x 1024, 1024 x 768)		
	VGA	1 VGA (1920 x 1080p, 1920 x 1080i, 1440 x 900, 1280 x 1024, 1024 x 768)		
	Main Composite	1 RCA Composite (1.0 Vp-p, 75 ohm)		
	Spot Composite	1 RCA Composite (1.0 Vp-p, 75 ohm)		
Audio	Inputs / Outputs	1 / 1	4 / 1	
	Compression	ADPCM		
	Sampling Rate	16 KHz		
Alarm	Inputs / Outputs	4 / 1	8 / 2	
Connections	Ethernet	1 RJ-45 10/100 Mbps Ethernet		
	Serial Interface	1 RS-485 Port for PTZ		
	USB	2 USB Ports		
	Application Support	Mouse, Handheld Remote Controller		
	PTZ Protocol Support	Clinton, Cyberscan I & II, Pelco D & P, NVCC-Z42N, Cyberdome (Kalatel), Samsung, Samsung Techwin, Sungjin, Dongyang, DRX-500, DS120, Fastrax II, Sensormatic, PIH-7600, Eyeview Dome, Erna Tech, DY-255RXB, Acut Vista, Panasonic WV-CS950, PTC-401C, HSDN-251, CTDC-5355, AD Speed Dome, VCL (Honeywell)		
GENERAL				
Electrical	Input Voltage / Current	100 - 220V AC ± 10% (50/60Hz)		
	Power Consumption	40 Watts	120 Watts	
Environmental	Operating Temp/Humidity	32°~104° F / 20~80 % RH		
Mechanical	Dimensions (WxDxH)	11.61" x 7.16" x 1.37"	13.77" x 10.15" x 2.75"	
	Weight	1.32 lbs (Without HDD)	2.64 lbs (Without HDD)	
	Rack Mount	N/A		
Language	User Selectable	English, Korean, Japanese, Chinese, Russian, French, German, Italian, Taiwan, Spanish, Portuguese		
Disclaimer	Design and specifications are subject to change without notice. For the most up to date information & specifications please visit www.clintonelectronics.com			

Specs - Pro Series

PRO SERIES		CE-DV800	CE-DVR1600
DISPLAY			
Video	Channels	8 Composite Video BNC Inputs	16 Composite Video BNC Inputs
Live	Frame Rate	240 FPS	480 FPS
	Multi Screen Display	1 / 4 / 7 / 9	1 / 4 / 7 / 9 / 10 / 13 / 16
PERFORMANCE			
Operating System	Embedded	Linux	
	Compression	H.264 Enhanced Compression Method	
	Performance	Pentaplex	
Record Rate	CIF (352 x 240)	240 FPS	480 FPS
	1/2 D1 (704 x 240)	240 FPS	480 FPS
	D1 (704 x 480)	240 FPS	480 FPS
Recording	Mode	Schedule / Continuous / Event (Motion, Alarm)	
	Overwrite Mode	Continuous / Off	
	Pre-alarm	Up to 60 seconds of Record Time	
	Post-alarm	Up to 100 seconds of Record Time	
Search & Playback	Search Mode	Date/Time, Event, Panorama (Frame by Frame), Smart Search	
	Playback Function	Fast forward/backward, Slow forward/backward, Step forward/backward	
Motion	Area	Adjustable Grid (22 x 15)	
	Sensitivity	5 Level Motion Detection	
System	Hidden Video Mode	Video is hidden from view while recording is still taking place	
	Private Zone	Black out an area in live and recorded view	
	Auto Time Sync	NTP (Network Time Protocol)	
	Firmware Update	Via USB or Auto firmware upgrade via Network Connection	
Event	SMART Alarm	Auto Detect and Monitor HDD problems	
	Source	Motion / Alarm In / Video Loss	
Network	Action	Record, E-mail Notification, Log File, Send message to Remote, Buzzer, Pop Up Window, Alarm, PTZ Preset	
	Transmission Speed	CIF 480/400 FPS (Max.)	
	Bandwidth	8 Mbps - 50kbps, SMS 1Mbps min.	
	Bandwidth Control	Selectable	
	Stream	H.264 (CIF)	
	Max. Remote Users	Search & Live = 10 Users (Max.)	
	Protocol Support	Static IP, DHCP, DDNS	
	Monitoring	SMS Software, Web Viewer (Windows Internet Explorer, Mac OS X Safari), Smart Phone (Android, iPhone iOS)	
Smart Phone	Remote E-mail Notification	Motion, Video Loss, Power, Menu, Login Fail, Disk Full, Login, SMART, Alarm In	
	Smart Phone	Google Android (Not compatible with all Android phones), Apple iPhone iOS	
Storage	Max. Remote Users	1 User	
	Internal HDD (Standard)	1 TB Standard HDD	
	Optional HDDs	2 TB or 3TB Optional HDD (Holds up to 3 internal HDDs) / Use eSATA external port for additional HDD options	
	Back Up	CD-RW, DVD-RW, HDD, eSATA, USB drive, or PC via SMS Remote Software	
Security	File Format	Proprietary DVR Format	
	Password Protection	2 Admin, 6 User	
	Data Authentication	Proprietary Data File	
INTERFACE			
Monitors	HDMI	1 HDMI (1920 x 1080p, 1920 x 1080i, 1600 x 1200, 1440 x 900, 1280 x 1024, 1024 x 768)	
	VGA	1 VGA (1920 x 1080p, 1920 x 1080i, 1600 x 1200, 1440 x 900, 1280 x 1024, 1024 x 768)	
	Main Composite	1 BNC Composite (1.0 Vp-p, 75 ohm)	
	Spot Composite	1 BNC Composite (1.0 Vp-p, 75 ohm)	3 BNC Composite (1.0 Vp-p, 75 ohm)
Audio	Loop Out	8 Composite Video BNC Outputs	16 Composite Video BNC Outputs
	Inputs / Outputs	8 / 1	16 / 1
	Compression	ADPCM	
Alarm	Sampling Rate	16 KHz	
	Inputs / Outputs	8 / 1	16 / 4
Connections	Ethernet	1 RJ-45 10/100 Mbps Ethernet	
	Serial Interface	1 RS-232/RS-485 Port for PTZ	
	USB	2 USB Ports	
	eSATA	1 eSATA Port for External RAID HDD Systems	
	Application Support	Mouse, Handheld Remote Controller	
	PTZ Protocol Support	Clinton, Cyberscan I & II, Pelco D & P, NVCC-Z42N, Cyberdome (Kalatel), Samsung, Samsung Techwin, Sungjin, Dongyang, DRX-500, DS120, Fastrax II, Sensormatic, PIH-7600, Eyeview Dome, Ema Tech, DY-255RXB, Acut Vista, Panasonic WV-CS950, PTC-401C, HSDN-251, CTDC-5355, AD Speed Dome, VCL (Honeywell)	
GENERAL			
Electrical	Input Voltage / Current	100 - 220V AC ± 10% (50/60Hz)	
	Power Consumption	60 Watts	
Environmental	Operating Temp/Humidity	32°~104° F / 20~80 % RH	
	Dimensions (WxDxH)	13.77" x 15.74" x 3.46"	
Mechanical	Weight	13.22 lbs (Without HDD)	
	Rack Mount	N/A	
Language	User Selectable	English, Korean, Japanese, Chinese, Russian, French, German, Italian, Taiwan, Spanish, Portuguese	
Disclaimer	Design and specifications are subject to change without notice. For the most up to date information & specifications please visit www.clintonelectronics.com		

Specs - HD-SDI Series

HD SERIES		CE-HDVR4
DISPLAY		
Video	Channels	4 HD-SDI BNC Inputs
Live	Frame Rate	30 FPS
	Multi Screen Display	1 / 4
PERFORMANCE		
Operating System	Embedded	Linux
	Compression	H.264 Enhanced Compression Method
	Performance	Pentaplex
Record Rate	HD (1920 x 1080)	30 FPS Global (7.5 FPS per Channel)
Recording	Mode	Schedule / Continuous / Event (Motion, Alarm)
	Overwrite Mode	Continuous / Off
	Pre-alarm	Up to 60 seconds of Record Time
	Post-alarm	Up to 100 seconds of Record Time
Search & Playback	Search Mode	Date/Time, Event, Panorama (Frame by Frame), Smart Search
	Playback Function	Fast forward/backward, Slow forward/backward, Step forward/backward
Motion	Area	Adjustable Grid (30 x 17)
	Sensitivity	5 Level Motion Detection
System	Hidden Video Mode	Video is hidden from view while recording is still taking place
	Private Zone	Black out an area in live and recorded view
	Auto Time Sync	NTP (Network Time Protocol)
	Firmware Update	Via USB or Auto firmware upgrade via Network Connection
Event	SMART Alarm	Auto Detect and Monitor HDD problems
	Source	Motion / Alarm In / Video Loss
Network	Action	Record, E-mail Notification, Log File, Send message to Remote, Buzzer, Pop Up Window, Alarm, PTZ Preset
	Transmission Speed	1080p 40 FPS (Max.)
	Bandwidth	8 Mbps - 50kbps, SMS 1Mbps min.
	Bandwidth Control	Selectable
	Stream	H.264 (CIF)
	Max. Remote Users	Search & Live = 10 Users (Max.)
	Protocol Support	Static IP, DHCP, DDNS
	Monitoring	SMS Software, Web Viewer (Windows Internet Explorer, Mac OS X Safari), Smart Phone (Android, iPhone iOS)
Smart Phone	Remote E-mail Notification	Motion, Video Loss, Power, Menu, Login Fail, Disk Full, Login, SMART, Alarm In
	Smart Phone	Google Android (Not compatible with all Android phones), Apple iPhone iOS
Storage	Max. Remote Users	1 User
	Internal HDD (Standard)	2 TB Standard HDD
	Optional HDDs	4 TB or 6TB Optional HDD (Holds up to 3 internal HDDs) / Use eSATA external port for additional HDD options
	Back Up	CD-RW, DVD-RW, HDD, eSATA, USB drive, or PC via SMS Remote Software
Security	File Format	Proprietary DVR Format
	Password Protection	2 Admin, 6 User
	Data Authentication	Proprietary Data File
INTERFACE		
Monitors	HDMI	1 HDMI (1920 x 1080p, 1920 x 1080i, 1440 x 900p, 1280 x 720p)
	VGA	1 VGA (1920 x 1080p, 1920 x 1080i, 1440 x 900p, 1280 x 720p)
Audio	Inputs / Outputs	4 / 1
	Compression	ADPCM
	Sampling Rate	16 KHz
Alarm	Inputs / Outputs	4 / 1
Connections	Ethernet	1 RJ-45 10/100 Mbps Ethernet
	Serial Interface	1 RS-232/RS-485 Port for PTZ
	USB	2 USB Ports
	eSATA	1 eSATA Port for External RAID HDD Systems
	Application Support	Mouse, Handheld Remote Controller
	PTZ Protocol Support	Clinton, Cyberscan I & II, Pelco D & P, NVCC-Z42N, Cyberdome (Kalatel), Samsung, Samsung Techwin, Sungjin, Dongyang, DRX-500, DS120, Fastrax II, Sensomatic, PIH-7600, Eyeview Dome, Erna Tech, DY-255RXB, Acut Vista, Panasonic WV-C950, PTC-401C, HSDN-251, CTDC-5355, AD Speed Dome, VCL (Honeywell)
GENERAL		
Electrical	Input Voltage / Current	100 - 220V AC ± 10% (50/60Hz)
	Power Consumption	60 Watts
Environmental	Operating Temp/Humidity	32°~104° F / 20~80 % RH
Mechanical	Dimensions (WxDxH)	13.77" x 15.74" x 3.46"
	Weight	13.22 lbs (Without HDD)
	Rack Mount	N/A
Language	User Selectable	English, Korean, Japanese, Chinese, Russian, French, German, Italian, Taiwan, Spanish, Portuguese
Disclaimer	Design and specifications are subject to change, without notice. For the most up to date information & specifications please visit www.clintonelectronics.com	



CLINTON Electronics

CLINTON Electronics

CLINTON Electronics
6701 Clinton Road
Loves Park, IL 61111

1.800.447.3306 **Sales**
1.800.549.6393 **Support**
1.800.633.8712 **Fax**

www.clintonelectronics.com

v.05.09.12